

2020

**OEM & Aftermarket
Catalog**



GLOBETECH
MANUFACTURING

Thank you for your
continued support.

Trailer Parts & Accessories	Page	Electrical Products	Page	Air Products	Page
Document Holders	2, 3	ABS Cables	57	Spring Brakes	91-94
Louvered Vents	4	Non ABS Cables	58-59	Diaphragms	95
Manifest Box	4	Plugs	60	Chamber Clamps	95
Placard Holders	5-6	Sockets	61	Standard Air Coils	96-97
Conspicuity Tape	7	Connectors	62	Extreme Weather Air Coils	98
Door Hardware	8-15	Junction Box	62	Air-Electric 3 to 1 Combo	99
Corner Irons.....	14	Adapters	63	Bulk Rubber Air Hose	100
Corner Cap	14	Protector Boots	63	Rubber Air Brake Hose Assemblies	101
Grab Handles	15	Rubber Cushion Clamps	64	Rubber Air Hose D.O.T. Brass Hardware	102-103
Registration Holders	16	Wire Clip	64	Nylon Air Hose Tubing	104
Vinyl Pouch.....	16	Rubber Grommet	64	Nylon Air Hose D.O.T. Brass Hardware	105
		Noseboxes.....	65	Quick Connect Push-In Hardware	106
Mud Flaps & Accessories		Circuit Breaker	66	Swivel Kits	105
G-Force Aerodynamic Mud Flaps.....	18	Ground Kits	66	Drain Valve	105
3/16" Diamond Rubber A/V Mud Flaps.....	19	Brush Kits	66	Nylon Tube Cutter	105
Rubber Material Specification	20	Poly Looms	67	Clamping Studs	106
Armor Guard Rubber Mud Flap	21	Socketbreakers	67	Crimping Hose Ends	106
Economy Chevron Rubber Mud Flap	22	Rubber Tractor Lamps	68	Slide Bars	107
Standard Rubber Mud Flap	23	License Plate Light	68	Tender Kits	107
Xtreme Rubber Mud Flap	24			Suspender Springs	107
Heavy Duty Anti-Spray Rubber Mud Flaps	25	Wheel End Products		Hose Separators & Holders	108
Quick Change Anti-Spray Mud Flap	25	Aluminum Alloy Hub Caps	69-71	Pogo Sticks	109
Quick Mount Anti-Sail Mud Flap	26	Hubodometer Brackets	71	Clevis Assemblies	110
Raintrapper Mud Flap	26	Pro Par Style Hub Caps	72	Slack Adjusters	111-119
Raised Molded Rubber Mud Flap	32	Window Kits & Plugs	73	Valves	120-130
Raised Molded Rain Guard Mud Flap	32	Hub Cap Gaskets	74	Air Dryers	131-133
Tireplast Mud Flap.....	28	Tempbolts	75	Gladhands	134-136
Mid Guard Mud Flap	27	Inner/Outer Wheel Hardware	76	Gladhand Accessories	136-140
Side Skirt Mud Flap	27	Hub Cap Hardware	77	Brake Shoe Hardware Kits.....	141
Colored Poly Mud Flap	27	PSI Hub Caps	78		
Silk-Screen Logo Rubber	30	Tire Inflation Hose	79	Miscellaneous	
Hot Stamp Logo Poly	31	Inner Tube	80	King Pin Locks & Gladhand Locks	143
Polyguard Standard	29	Tire Repair Tool Kit	80	Fifth Wheel Puller.....	144
Polyguard Plus Anti-Spray Mud Flaps	29	Tire Inflator Kit	81	Coil Rack.....	144
Polyguard Plus HD Anti-Spray Mud Flaps	29	Tire Chucks/Tire Gauges	81	Slick Doscs.....	144
Stock Logo Mud Flaps	36,37	Valve Stems	82	Triangle Kits	145
Custom Logo Mud Flap Forms	34-35	Valve Stem Caps	83	Lock Rod Assembly	146
Wheel Chocks.....	38	Standard Bore Valve Tool	83	Cross-Reference Page	147-150
Trailer Bumpers	39-41	Freeze Plugs	84	Index	151-157
Laminated Bumpers	42			Notes	158-159
Door Bumpers	42			Warranty	160
Bar Type Mud Flap Hangers.....	43-44				
Mounting Brackets for Hangers	45	Gen2 ABS			
Mud Flap Bolt Kits	46	4S/1M Comparison.....	83-86		
Bulk Display Hangers	46	ECU's & GEN2 2S/1M	87		
Conspicuity Accessories	47	GEN2 ABS Parts List.....	88		
Spring Loaded Brackets	48-50	GEN2 ABS Parts List.....	89-90		
Quarter Fenders	51-52				
Quarter Fender Top Flaps	53				
Quarter Fender Hardware	53-54				
Quick Reference Guide	56				



Document Holders



GT-1001

- UV-resistant Dow Corning CALIBRE polycarbonate lens
- EPDM rubber seal for weather proofing

Part Number	Description	Replaces Betts#
GT-1001	Plastic document holder outside: 6" x 5" x 1-2/3" inside: 4-1/4" dia, 1" depth	PS-1
GT-1001S	O-ring seal for GT-1001	BTL-820012
GT-1004	Replacement lens & seal kit	BTL-71P5



GT-1007

- UV-resistant Dow Corning CALIBRE polycarbonate lens
- Water resistant seal, retaining spring, locking design

Part Number	Description	Replaces Trucklite#
GT-1007	Twist lock document holder w/wire outside: 6" x 5" x 2-1/2" inside: 3-3/4" dia, 1" depth	97960
GT-1008	Replacement lens & seal kit	TL-97962



GT-1003

- EPDM rubber caps for UV-resistance
- Stainless steel cable eliminates loss of end caps
- Pre-drilled mounting brackets

Part Number	Description	Replaces Fleet Engineers#
GT-1003	Tube style document holder w/ rubber end caps, 9" length, 1-1/2" diameter, 4" bracket height	022-01190
GT-1005	Replacement cap For GT-1003	



GT-1006

- Stainless steel hardware
- Poron gasket

Part Number	Description	Replaces James King#
GT-1006	Security box, die cast outside: 7" x 5-1/4" x 2" Clipboard: 3-1/2" x 5-1/4"	Model 300
GT-1009	Replacement lid kit for GT-1006	



Document Holders

- High-tech plastic is unaffected by weather, chemicals, or corrosion
- Rainshield lid & water resistant seal
- Side clips prevent accidental opening



GT-1035

Part Number	Description	Replaces James King#
GT-1035	Xenoy document holder overall: 7" x 5-1/4" x 2" inside: 5" x 3-1/2" x 1"	Model 350
GT-1035B	Document holder, body only for GT-1035	—
GT-1035L	Replacement Lid Kit for GT-1035	—



GT-1050

- Holds papers and binders up to 10" x 14"
- Sliding lid with rainshield
- Internal document shelf

Part Number	Description	Replaces James King#
GT-1050	Large plastic record holder outside: 16" x 11-1/2" x 1-1/2" inside: 14" x 10" x 1-1/2"	Model 500
GT-1050L	Replacement Lid Kit for GT-1050	—



GT-1055

- Flip open lid features triple latch for secure close
- Interior clip & document shelf

Part Number	Description	Replaces James King#
GT-1055	Flip plastic record holder outside: 15" x 10" x 1-1/4" inside: 12-1/4" x 9-1/2" x 3/4"	Model 550
GT-1055L	Replacement Lid Kit for GT-1055	—



Louvered Vent

- Louvered Aluminum



GT-1105

Part Number	Description	Replaces Fleet Eng. #
GT-1105	Slide by vent	024-03000
GT-1105B	Slide by vent, black	—

Manifest Box

- Lightweight aluminum body, stainless steel hinge & latch
- Outside: 13" x 8" x 1-1/2"
- Inside: 11-1/2" x 6-1/2" x 1-1/4"
- Available with custom logo



GT-1002

Part Number	Description	Replaces Fleet Engineers#	Replaces James King#
GT-1002	Aluminum manifest box	022-01087	Model 200
GT-1002WHT	White manifest box	—	—



GT-04400035

- Pre-drilled to hold GT-1002 manifest box
- Powder coated finis

Part Number	Description	Replaces Wabash
GT-04400035	Aluminum pan for GT-1002	04400035



Placard Holders



GT-1100

• Louvered Aluminum



GT-1102

• Plastic



GT-1100A



GT-1103

Part Number	Description	Replaces
GT-1100	Standard aluminum placard holder w/stainless clip & back plate	80SM-4CC Labelmaster
GT-1101	Standard placard holder, white w/stainless clip & back plate	—
GT-1102	Plastic placard holder	JJK2-TPH JJ Keller

Part Number	Description	Replaces Labelmaster#
GT-1100A	Aluminum placard holder, angle cut w/back plate	80SM-P
GT-1101A	White placard holder, angle cut W/back plate	—
GT-1103	Aluminum face	4-TPH
GT-1111	Stainless Steel clip	



GT-1111

Stainless Steel replacement clip



GT-1150

GT-1150 (Aluminum) GT-1150W (White)	GT-1151 (Aluminum) GT-1151W (White)
<ol style="list-style-type: none"> 1. Explosive 2. Flammable Gas 3. Corrosive 4. Dangerous 5. Flammable 6. Non-Flammable Gas 7. Oxidizer 8. Poison 9. Radioactive 10. Blank White 	<ol style="list-style-type: none"> 1. Corrosive 2. Flammable Gas 3. Radioactive 4. Flammable 5. Plain White 6. Dangerous 7. Oxidizer 8. Non-Flammable Gas 9. Poison
Replaces Labelmaster #81-10FO	Replaces Labelmaster #81-8FO



Placard Holder

GT-1108
Aluminum Placard Holder
Small 5x7

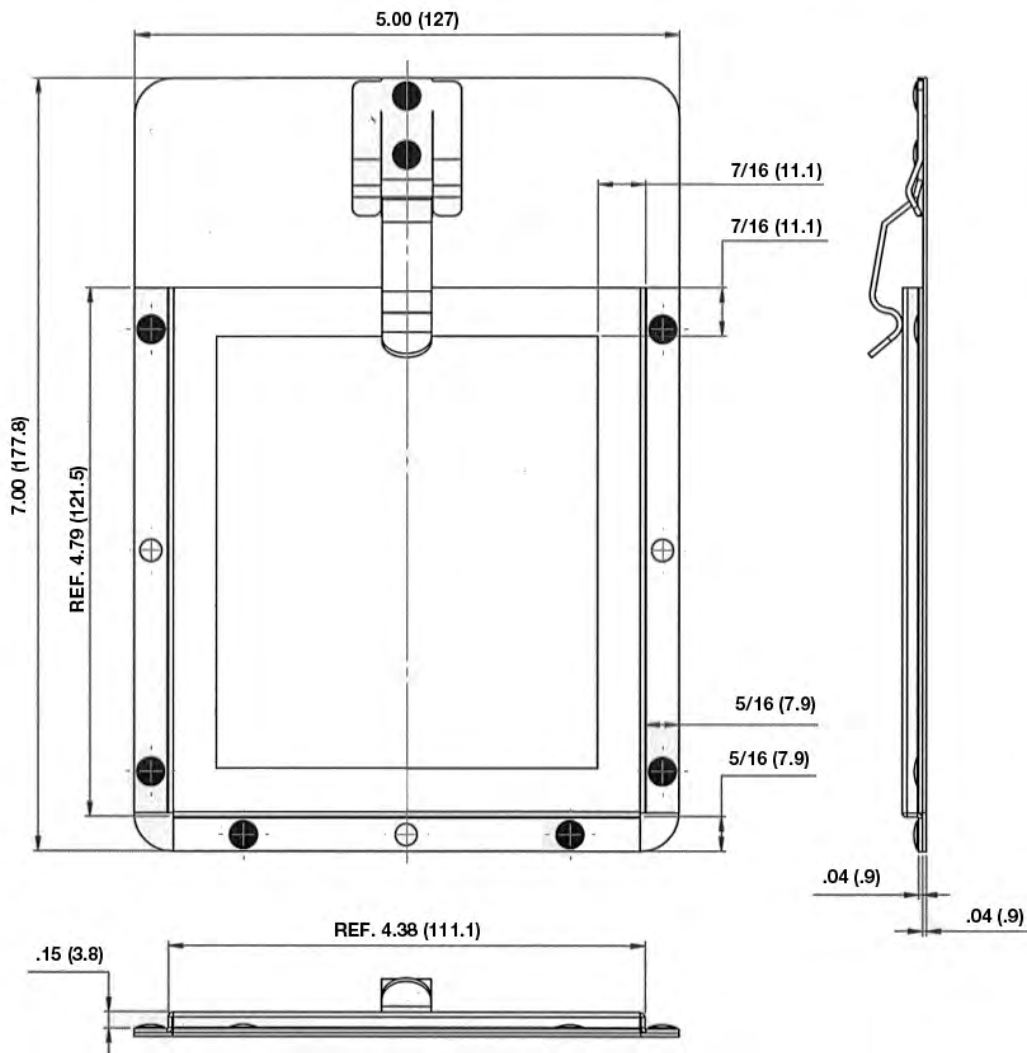
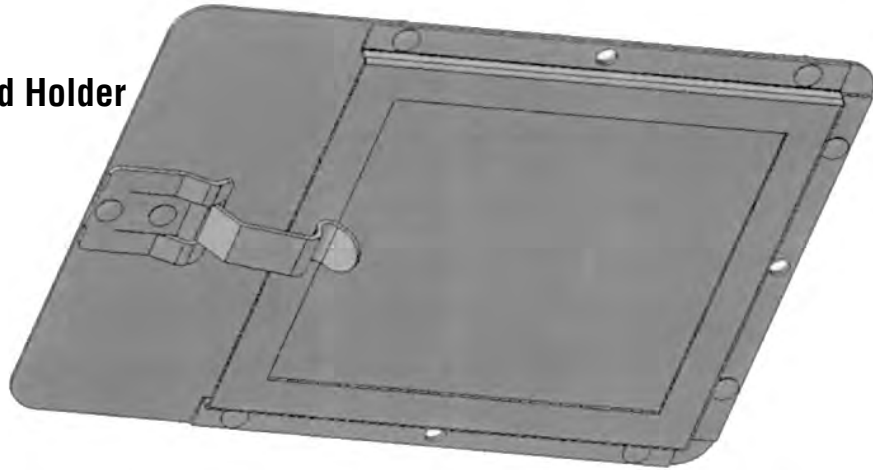



Conspicuity Tape Benefits

- DOT tape is certified and guaranteed to meet and exceed NHTSA requirements
- Durable – resists weather, dirt and aging
- Aggressive adhesive: DOT Specs
- Non – corroding
- Strong and durable for easy application to smooth surface
- New thin, flexible prismatic for smooth surface, and around rivets and corners



Color Plots

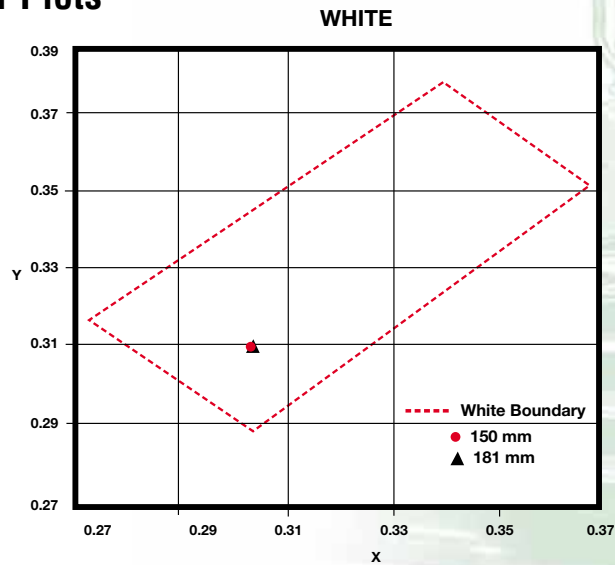
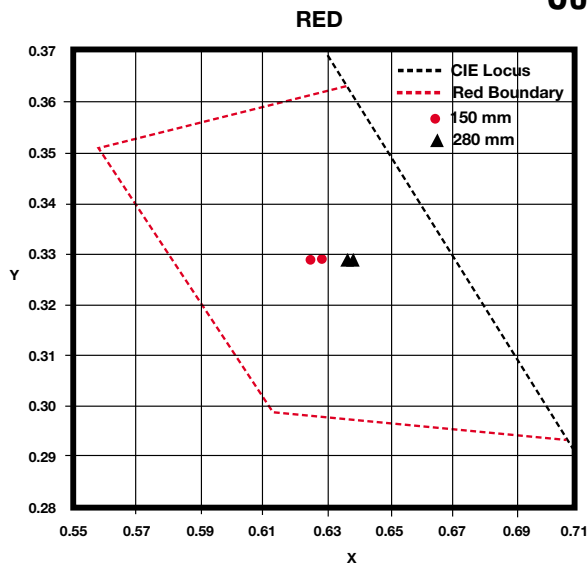

Part No.	Color	Width	Unit	Length	Quantity	Replaces 3M ID
GT-27003	Red & White	2 inch	6" Red x 6" White Roll	150 ft	1	75-0301-6343-2
GT-27004	Red & White	2 inch	11" Red x 7" White Roll	150 ft	1	75-0301-6340-8
GT-27005	White	2 inch	Roll	150 ft	1	75-0301-6345-7
GT-27006	Yellow	2 inch	Roll	150 ft	1	
GT-27007	Orange	2 inch	Roll	150 ft	1	



Holdbacks



Part Number	Description	Replaces Wabash #
GT-1301	Door holdback hook, galvanized mounting plate: 2" x 2-3/16" hook height: 2-1/4"	06300015

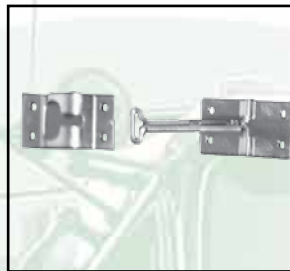

Part Number	Description	Replaces Wabash #	Replaces Fleet Engineers #
GT-1302	"T" type door holdback T bar length: 4", base: 1-3/4" x 3"	06300028	022-01022
GT-1326	"T" type door holdback T bar length: 6", base: 1-3/4" x 3"	-	022-01024

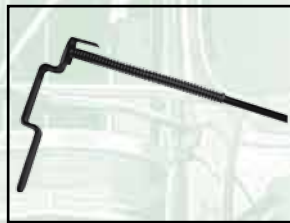

Part Number	Description	Replaces Wabash #
GT-1303	Stainless steel spring holdback width: 11-1/2", length: 20-1/2"	06300094



Part Number	Description	Replaces Wabash #
GT-1306	Holdback hook #XCD-0262-1, galvanized	06300119

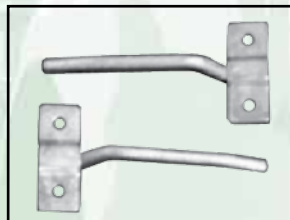

Part Number	Description	Replaces Wabash #	Replaces Eberhard #
GT-1307	Door holdback post, galvanized mounting plate: 3-1/4" x 1-1/4" post length: 6-3/4"	06300693	6602-50



Part Number	Description	Replaces Wabash #	Replaces Eberhard #
GT-1312	Door holdback post, galvanized mounting plate: 1-1/4" x 3-3/16" post length: 4-11/32"	06301964	6603-50



Loops & Snaps

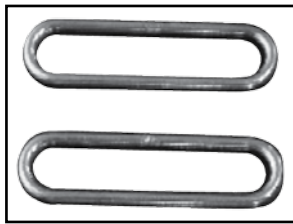

Part Number	Description	Replaces Wabash #	Replaces Eberhard #
GT-1313	4" chain loop	06302523	6601-3



Part Number	Description	Replaces Wabash #
GT-1314	Galvanized snap, 1/2"	06300058

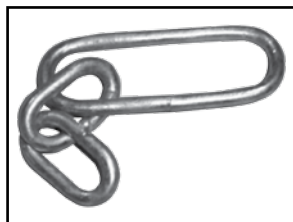

Part Number	Description	Replaces Wabash #
GT-1316	4" loop, galvanized, 2 small links	06300985

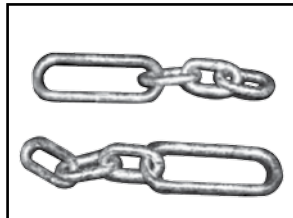

Part Number	Description	Replaces Wabash #
GT-1317	4" holdback loop, galvanized, 3 small links	06302613

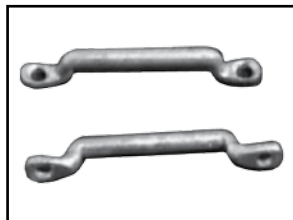

Part Number	Description	Replaces Wabash #	Replaces Fleet Engineers #
GT-1300	Footman loop, galvanized overall length: 3-1/2", C-C: 2-3/4"	A1300017	021-00043

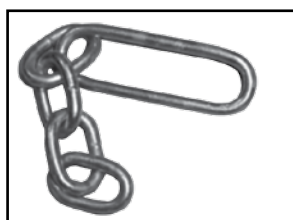

Part Number	Description	Replaces Wabash #	Replaces Eberhard #
GT-1305	Holdback loop, galvanized large link: 4", 4 small links	06300118	6608-1 (3" large link)



Door Sockets/Plunger

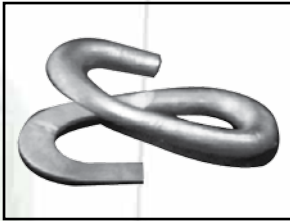

Part Number	Description	Replaces Wabash #	Replaces Fleet Engineers #
GT-1304	Loop attach link #DCC-07478-1 galvanized	06300117	021-00053



Part Number	Description	Replaces Wabash #	Replaces ORR #
GT-1308	Plunger, galvanized, 1-5/8"	06300805	H9013



Part Number	Description	Replaces Wabash #
GT-1315	Socket w/o rubber insert, galvanized	06300844



Part Number	Description	Replaces Wabash #	Replaces Eberhard #
GT-1309	Female rubber socket w/ steel insert	06301166	1-666-2 (female portion only)



Part Number	Description	Replaces Wabash #	Replaces Eberhard #
GT-1310	Male insert for GT-1309	06301167	1-666-2 (male portion only)



Part Number	Description	Replaces Wabash #
GT-1318	Rubber insert	06301217



Door Hardware



Part Number	Description	Replaces Fleet Engineers #
GT-1323	Door holdback, 6" loop used in post style holdback kits	022-01078



Part Number	Description	Replaces Fleet Engineers #
GT-1324	5" footman loop 5" overall length 4-1/4" C-C	022-00628



Part Number	Description	Replaces Fleet Engineers #
GT-1327	Holdback loop, Fruehauf style 8-1/2" overall length 2-1/4" x 2/3" base plate	022-00487



Part Number	Description	Replaces Wabash #	Replaces Fleet Engineers #
GT-1328	Door holdback w/3 chain links & HD snap	525461	021-00050



Part Number	Description	Replaces Todco
GT-1400	End hinge, T-style, zinc-plated, for roll up doors	69035



Part Number	Description	Replaces Todco
GT-1401	Center hinge, zinc-plated, for roll up doors	61196



Door Hardware

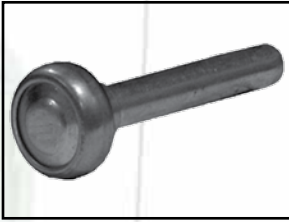

Part Number	Description	Replaces Todco#
GT-1402	1" steel roller	61174

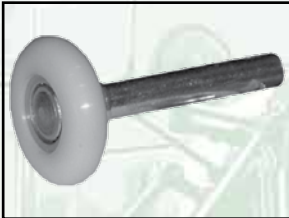

Part Number	Description	Replaces Todco #
GT-1403	2" nylon roller	70225

Kit Replacements

Create kits similar to Fleet Engineer kits with standard Globetech components:



GT-1331



GT-1332



GT-1333

Globetech Kit	Globetech replacement part numbers for kit	Description	Replaces Fleet Engineers kit#
GT-1331	(1) GT-1300 and (1) GT-1328	Handle style anchor, chain, lap link & snap	021-00051
GT-1332	(1) GT-1324, (1) GT-1313 and (1) GT-1307	Handle, post holdback & 4" loop	021-00373
GT-1333	(1) GT-1324, (1) GT-1323 and (1) GT-1307	Handle, post holdback & 6" loop	021-00374



Wabash Style Holdback Oblong Loop and Chain Kit

GT-1329 Oblong Loop and Chain
Replaces WAB06302250

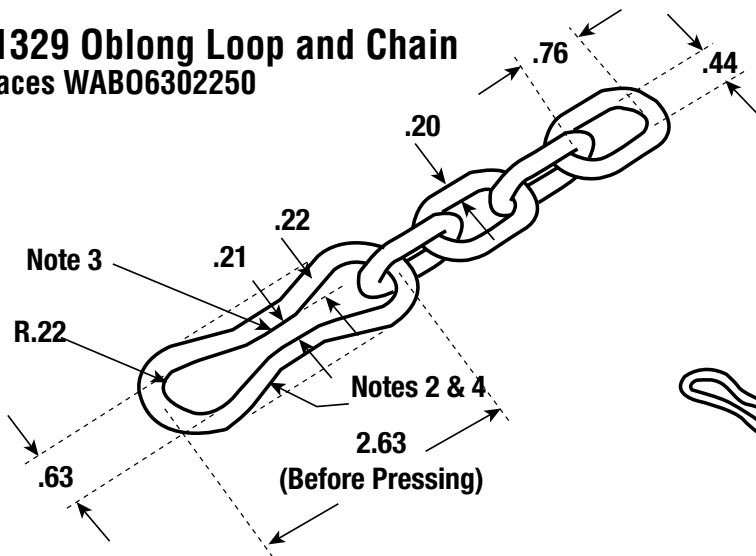

GT-1311 Hook
Replaces WAB06302200

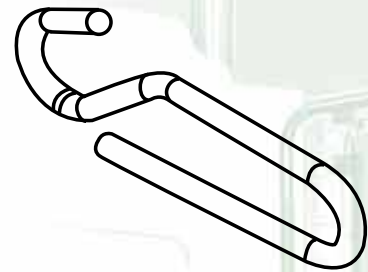

Notes:

1. Four 4/0 Passing links-welded
2. Weld oblong link-grind so there is maximum .03 high flashing
3. Press in sides of oblong link to within .21 of each other
4. Oblong link weld should be free of cracking after pressing

GT-1334 Kit
Replaces WAB06302201



GT-1334 Kit Includes

- GT-1311 Hook
- GT-1329 Oblong Loop and Chain

GT-1336 Kit
Wabash Style Vent Door
Holdback Loop
Replaces WAB06303036





Corner Irons

High strength, drop forged steel construction

GT-1201 – OEM
GT-1202 – Aftermarket

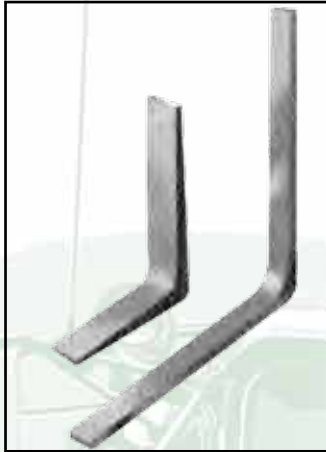

Part Number	Replaces	Size	Weight
GT-1201	B24878	8"x6"x1-1/2"	2.7lb
GT-1202	B2485aa	12"x12"x1-1/2"	4.5lb

GT-1200P-Corner Cap Freuhauf Style

Replaces:
Freuhauf - FruWC F9
Plastic nylon



VISIT US ONLINE AT GTMANUFACTURING.COM

USA MANUFACTURING

OEM QUALITY TRAILER PARTS





Grab Handles

Part Number	Description
GT-5377	18"
GT-5378	24"



Steel Grab Handle

- Available in zinc and chrome finishes

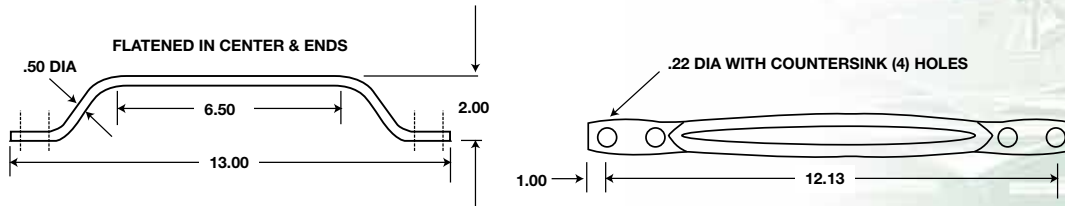

Part Number	Weight(lbs.)	Popularity Code	Construction	Cross Reference
GT-1114	.80	A	Zinc plated steel	Eberhard #4300 zinc
GT-1114C	.80	A	Chromed steel	Eberhard #4300 chrome

Aluminum Grab Handle

- Aluminum construction

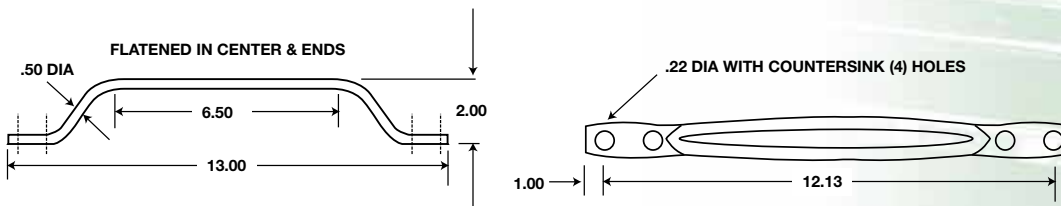

Part Number	Weight(lbs.)	Popularity Code	Construction
GT-1124	.80	A	aluminum



Registration Holder

NEW HOT ITEMS!

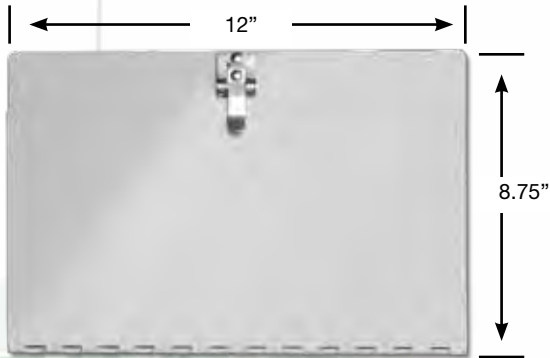

GT-1106

- Aluminum
- Powder coated finish

Part Number	Description
GT-1106	8.75" x 12" Replaces JJ Keller JJK 1RSP-DD
GT-1107	10.5" x 13" Registration Holder
GT-1111	Stainless Steel Clamp

GT-1107

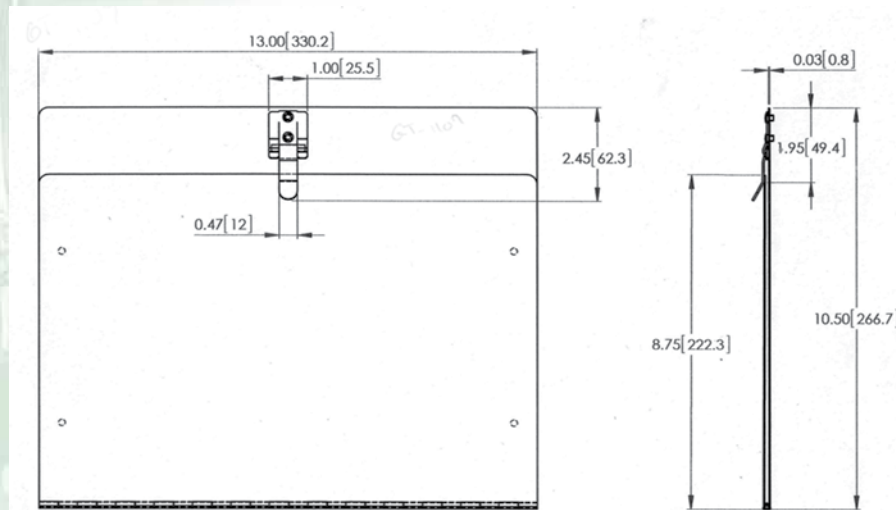

GT-1011 Water Proof Vinyl Pouch

Replaces Grote 43411-3

- All weather protection for permits, licenses, inspection stickers
- Self-sealing zipper protects from moisture and dirt
- Mounting: Four brass eyelets
- Sizes: 5-3/4" Wx8-1/4"L





BRACKETS • MUD FLAPS • QUARTER FENDERS

**RUBBER & POLY
CUSTOM MUD FLAPS**



G-Force Aerodynamic Mud Flaps

The Ultimate Aerodynamic Mud Flap Reduces Fuel Costs!

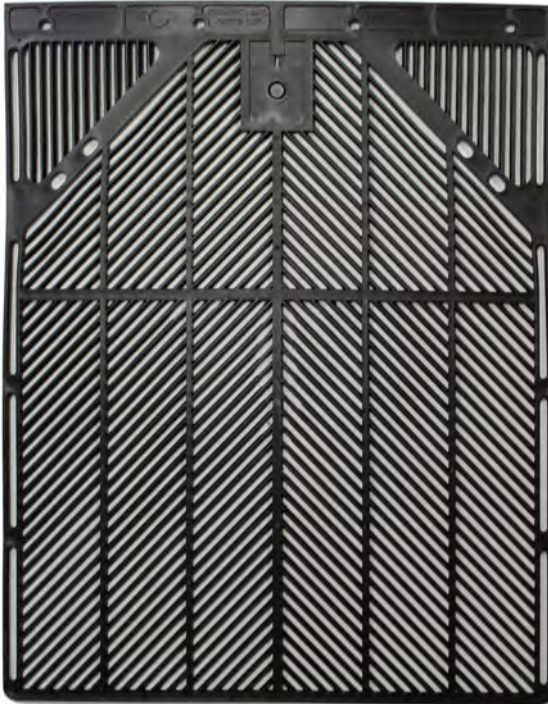

Part Number	Description	Weight Per Pair
GT-2424GFB	24x24 G-Force Aerodynamic Flap	10 lbs.
GT-2430GFB	24x30 G-Force Aerodynamic Flap	12 lbs.

- Reduces Fuel Costs
- Reduces Spray
- Anti-Sail
- Cold Temps to -42 degrees
- Optional LED light

Endorsed by Wright-Patterson Air Force Base

"Symmetric wing shaped airfoil design for each rib provides lowest drag coefficient optimizing air flow and improving fuel efficiency. Aerodynamic design allows air to through reducing movement of mud flaps at higher speeds maintaining their protective function. Vertical and angled ribs help to dissipate moisture and debris in a safe manner at all weather conditions and speeds. The G-Force 400 is weighted at an optimal 4.5 pounds and will not flex, bend or rotate at higher speeds. As an engineer I endorse this product due to its aerodynamic angled rib foil design allowing air to pass through yet keeping its protective function giving customers a fuel efficient durable mud flap."

-John G. Czikk, C-130 Avionics Modernization Program Engineer
Wright Patterson Air Force Base
Dayton, Ohio

Custom Logo G-Force Aerodynamic Mud Flaps

Have your logo printed on our G-Force Aerodynamic Mud Flaps

Part Number	Description	Weight Per Pair
GT-2424GFL	24x24 Logo G-Force Aerodynamic Flap	11 lbs.
GT-2430GFL	24x30 Logo G-Force Aerodynamic Flap	13 lbs.

- Great way to advertise your company!
- Reduces Fuel Costs
- Reduces Spray
- Anti-Sail
- Cold Temps to -42 degrees
- Optional LED light



Watch the Video on  YouTube
or Visit our Website



3/16" Economy DIAMOND Rubber AV Mud Flaps

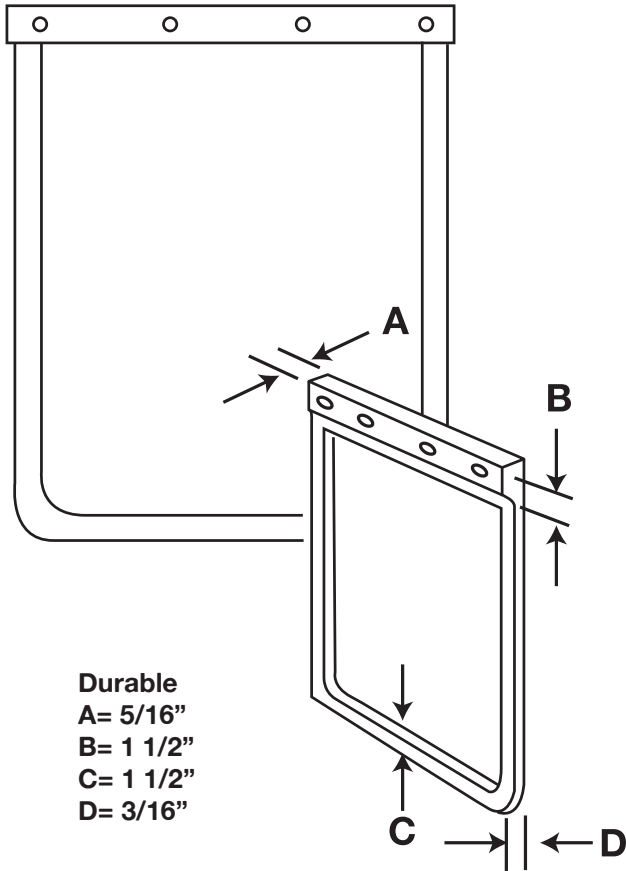

Globetech's Diamond Mud Flaps

Globetech uses the finest material available to mold its Diamond mud flaps. These are very popular mud flaps for everyday use including off road and over the road applications.



★ **MOLDED IN USA** ★

Part Number	Description	Weight Per Pair
GT-2424D	24x24 Diamond Economy Mud flap	8 lbs.
GT-2430D	24x30 Diamond Economy Mud flap	12 lbs.
GT-2436D	24x36 Diamond Economy Mud flap	14 lbs.



ARMOR GUARD COMPOUND

Unvulcanized Friction Compound



Globetech Compound 6807

Typical Properties:

Density:	1.16± .04 gms/cm
Shore A Durometer:	70 Duro ± 8
Tensile Strength:	2000 Minimum
Elongation	300% Minimum

Globetech Material Reinforced Ultimate Tear Strength!

Basic Material is commercial productive tire tread compound or similar. Reinforced with polyester and nylon fiber. SBR/NR

ASTM D624 - 00(2012)

Standard test method for tear strength of conventional vulcanized rubber and thermoplastic elastomers

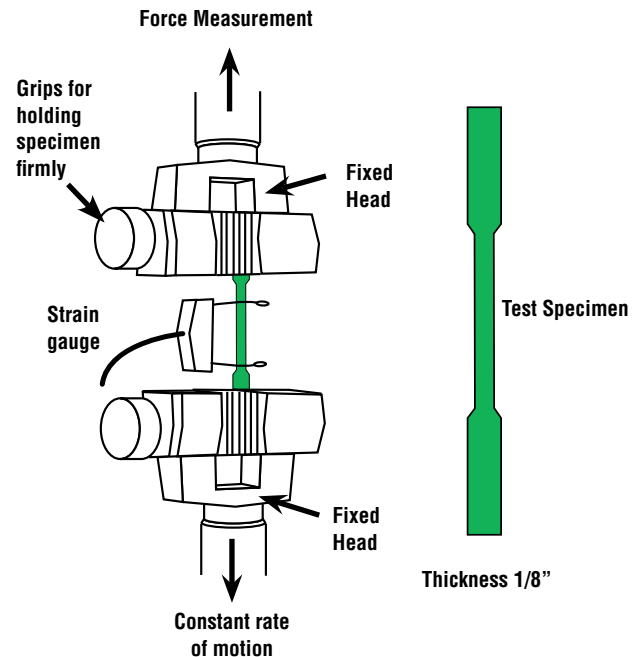
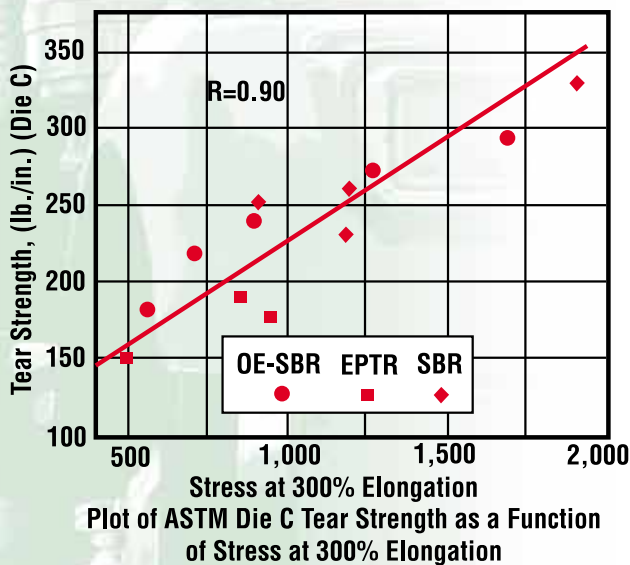



ARMOR GUARD Rubber Mud Flaps

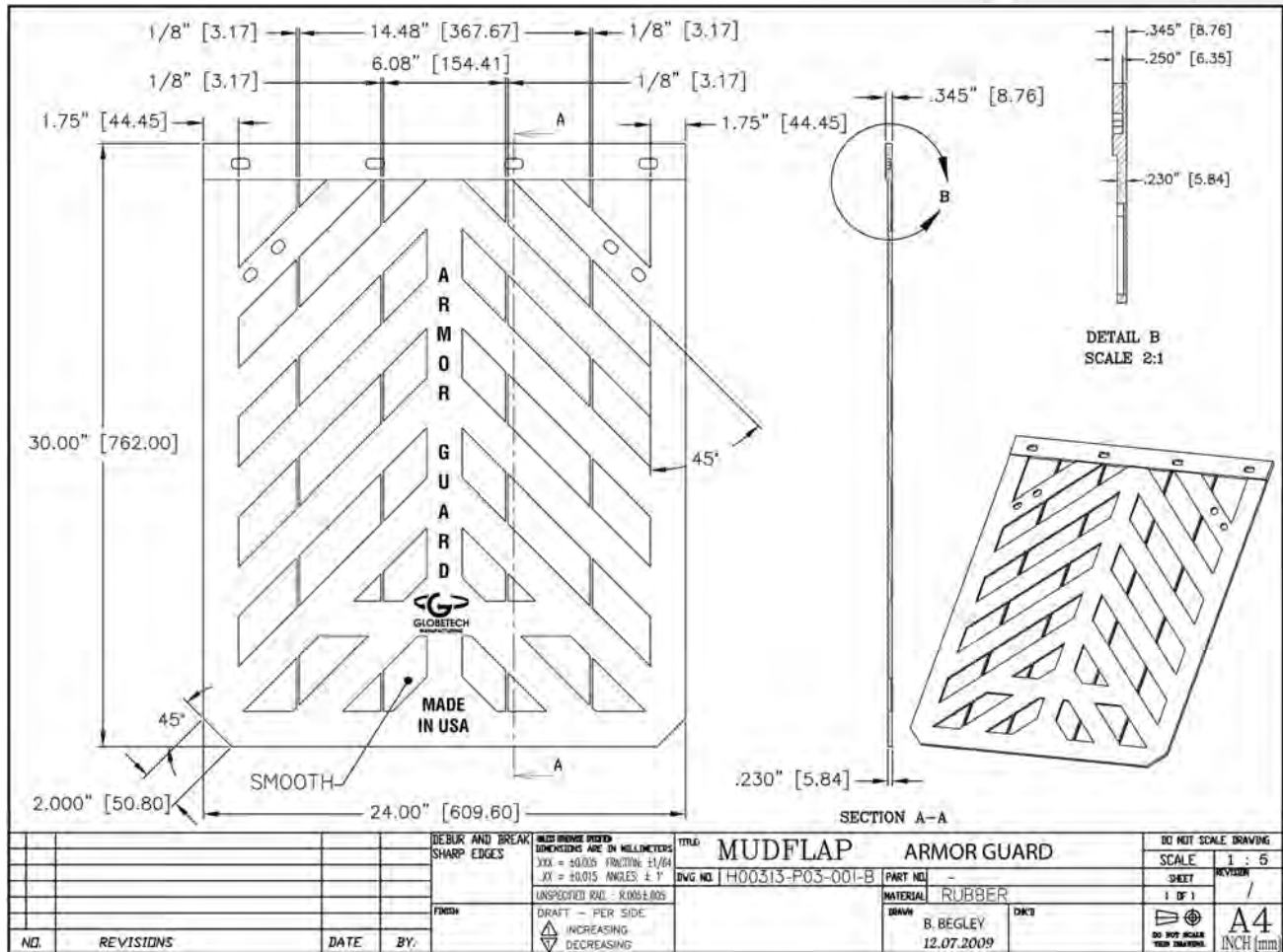

Rubber Mud Flaps



ARMOR GUARD MUD FLAP

The Armor Guard splash guard is made from 100% fiber reinforced rubber. The header is molded thicker to resist tearing through normal use. The top corners can be cut to fit standard 45 degree angle brackets. While the bottom can be cut down when a shorter flap is needed.

**100% High Tear Strength
Best Flap On The Market!**

Part Number	Description	Weight Per Pair	Replaces No.
GT-2424CD	24x24 Armor Guard Domestic	12 lbs.	062424
GT-2430CD	24x30 Armor Guard Domestic	14 lbs.	062430
GT-2436CD	24x36 Armor Guard Domestic	16 lbs.	062436



Imported Economy Chevron Mud Flaps



CHEVRON MUD FLAP

This is our economy least expensive mudflap. These flaps are thinner and molded from natural rubber and reinforced with "Small Fibers". This flap has a High tear strength!

Look for the  logo! Many import chevrons are not made by Globetech and tear easy.

Part Number	Description	Weight Per Pair
GT-2424C	24x24 Chevron Economy Mud flap	10 lbs.
GT-2430C	24x30 Chevron Economy Mud flap	12 lbs.
GT-2436C	24x36 Chevron Economy Mud flap	14 lbs.

ASTM Standard Testing

- **Hardness: 80A**
- **Elongation: 200%**
- **Tensile: 4.2 MPA (609)**
- **Tear Strength: K/NR 30 (171)**
- **Spec. Gravity 1.39**

Tear Resistance

The resistance to growth of a nick or cut when tension is applied to the cut specimen. (ASTM D-624.)

Tensile Strength

The tensile strength of a rubber compound is its resistance to rupture under tension. It is measured as strength at break and expressed in pounds per square inch of cross section. This property has an absolute value in some applications where the product is actually subjected to tension in service but, like the other tension properties, it is most frequently used in evaluating compounding materials on a cooperative basis.

In a series of cures with a variable time factor the tensile strength either passes through a maximum or exhibits a marked change in the slope of its curve. Therefore, the tensile strength may be considered either separately or together with the modulus and elongation in defining an optimum state of cure for any specific compound.



Mudflaps & Accessories



5/16" Standard Rubber Mud Flaps

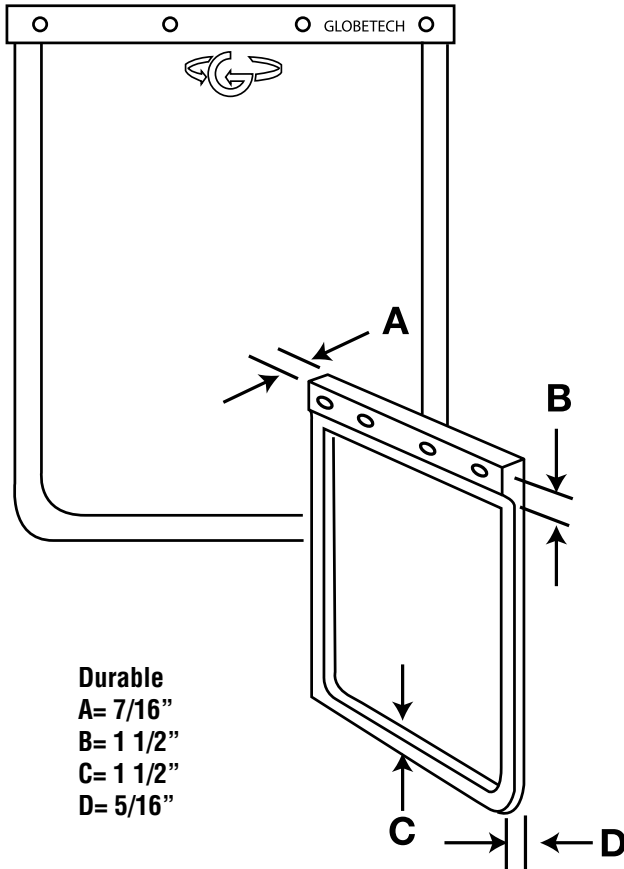

Globetech's Standard Mud Flaps

Globetech uses the finest material available to mold its standard mud flaps. These are the most popular mudflaps for logo use.

This material also meets all MIL-SPEC for Military Contractors.



Our 5/16" Standard splash guards are slightly heavier than our Chevron flaps. The majority of our customers prefer the Standard flap for their Custom logos.

★ MOLDED AND PRINTED IN USA ★

Part Number	Description	Weight Per Pair
GT-1218S	12x18 Standard Rubber Mud Flap	4 lbs.
GT-1924S	19x24 Standard Rubber Mud Flap	5 lbs.
GT-2015S	20x15 Standard Rubber Mud Flap	7 lbs.
GT-2414S	24x14 Standard Rubber Mud Flap	11 lbs.
GT-2418S	24x18 Standard Rubber Mud Flap	11 lbs.
GT-2424S	24x24 Standard Rubber Mud Flap	13lbs.
GT-2430S	24x30 Standard Rubber Mud Flap	15lbs.
GT-2436S	24x36 Standard Rubber Mud Flap	17lbs.



3/8" XTREME Rubber Mud Flaps



Nylon Mesh Reinforcement

Part Number	Description	Weight Per Pair
GT-2424XD	24x24 3/8" XTREME Mud Flap	16 lbs.
GT-2430XD	24x30 3/8" XTREME Mud Flap	17 lbs.
GT-2436XD	24x36 3/8" XTREME Mud Flap	19 lbs.
GT-2440XD	24x40 3/8" XTREME Mud Flap	21lbs.
GT-2442XD	24x42 3/8" XTREME Mud Flap	24lbs.



XTREME



Correlation of Constrained Path Tear versus Off Road Tire Performance

The chart below illustrates the degree of correlation between CP tear strength at 100°C and the cutting-chipping rating of a series of compounds in an off-road tire performance test.

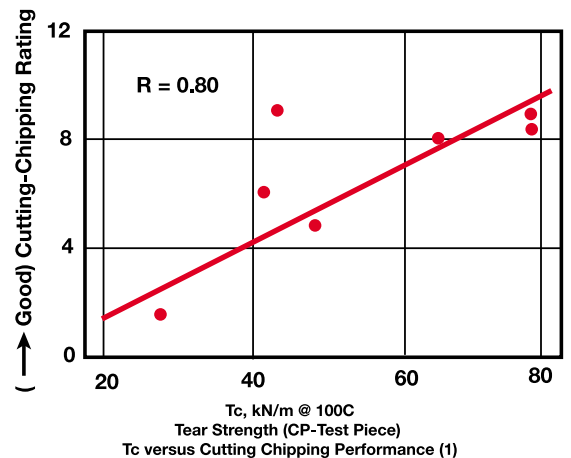

XTREME MUD FLAP

- Our Xtreme Mud Flap is molded from high tensile strength rubber. Using conveyor belt technology, a wire of nylon sheet is molded into the mud flap for greater durability.
- Great for dump trucks and off-road use
- Highest tear strength of any mud flap
- Stiffer flap prevents waving
- Available with silk-screen or raised molded logo

ABSOLUTE TOUGHEST FLAP ON THE MARKET!
REPLACES: STA-PUT-FLAPS



1/2" HEAVY DUTY Anti-Spray Mud Flaps



The **Heavy-Duty, Anti-Spray Flap** is the ultimate flap. The 1/2" thick reinforced rubber gives the flap anti-sail features. Raised knobs on the back side for anti-spray.

Part Number	Description	Weight Per Pair	Replaces Koneta
GT-2424HDD	24x24 1/2" Heavy Duty USA Mud Flap	19 lbs.	082424
GT-2430HDD	24x30 1/2" Heavy Duty USA Mud Flap	22 lbs.	082430
GT-2436HDD	24x36 1/2" Heavy Duty USA Mud Flap	24 lbs.	082436

- 45 Degree angle mount capable
- 30/36 dual mount capable
- Hole at bottom of flap for hook up
- Available with silk-screen or raised molded logo

Quick Change, AS Anti-Spray Mud Flaps



Part Number	Description	Weight Per Pair	Replaces Koneta
GT-2424AS	24x24 Quick Change Anti-Spray Mud Flap	18 lbs.	84500
GT-2430AS	24x30 Quick Change Anti-Spray Mud Flap	24 lbs.	84502
GT-2436AS	24x36 Quick Change Anti-Spray Mud Flap	30 lbs.	84504

ALL-RUBBER ANTI SPRAY QUICK CHANGE MUD FLAPS

Save time and money with two-step Quick Change Mud Flaps!

The Quick Change Anti-Spray mud flap features the easy two-step quick changeability plus finger-like projections directing spray downward while the built-in side ridges prevent lateral spray.

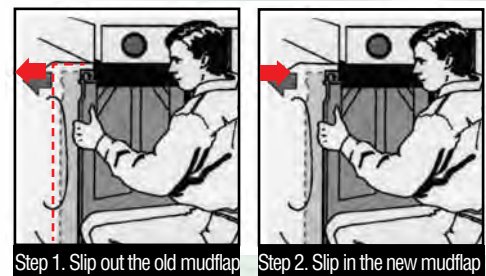

Step 1. Slip out the old mudflap

Step 2. Slip in the new mudflap



Anti-Sail Quick Mount Mud Flaps



Two embedded, all-steel bars resist wind force, even at high speeds. The convenience of quick maintenance combined with the stability of steel reinforcement bars.

Part Number	Description	Weight Per Pair	Replaces Koneta
GT-2430M	24x30 3/8" Quick Mount Mud Flap	20 lbs.	82506
GT-2436M	24x36 3/8" Quick Mount Mud Flap	22 lbs.	82504

Raintrapper Rubber Mud Flaps



The Raintrapper flap is manufactured in the U.S.A. by Globetech Manufacturing. This is the ultimate anti-spray mud flap for the heavy duty trucking industry. The Raintrapper mud flap features the finger-like projections directing spray downward while the built-in side ridges prevent lateral spray.

Part Number	Description	Weight Per Pair	Replaces Koneta No.
GT-2430RT	24x30 Raintrapper Flap	20 lbs.	84502

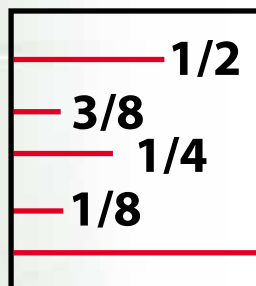
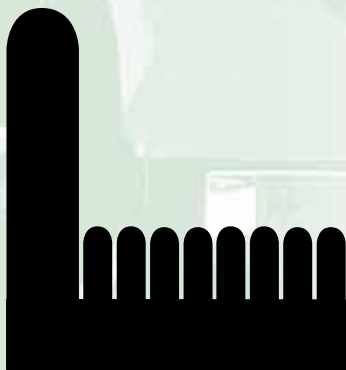

← Profile diagram showing finger-like projections



MidGuard Mud Flaps

MidGuard Mud Flaps provide unsurpassed protection from flying gravel, splash and road spray. Available in three thicknesses.

Part Number	Description	Replaces
GT-443638	3/8" x 44" x 36"	140002
GT-4224XD	3/8" x 42" x 24"	n/a



A MUST HAVE FOR DUMP TRUCKS!

Side Shields

- Side Shields offer ribbed construction to reduce spray from sides of trailers.



Part Number	Description	Replaces
GT-848S	Side Skirt Fap, 8" x 48" Rubber	074807

Colored Poly Flaps also available – 24" x 30" x 3/16" Only

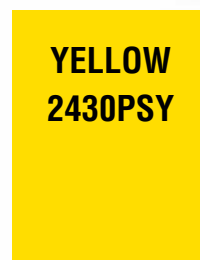

****Other sizes and thicknesses may also be available****



Tireplast Mud Flaps

This recycled rubber is a combination of recycled rubber (from tires) and plastic, tireplast is environmentally friendly and allows for custom product specifications. A great replacement for most natural and synthetic rubber, tireplast has low temperature impact toughness, tensile strength, flexibility, and sound deadening capabilities. Tireplast is resistant to many chemicals including alcohol, anti-freeze, diesel fuel, gasoline, grease, hydraulic oil, kerosene, motor oil, distilled water, and salt water.

Finished Products

- Mats & Runners
- Drainage Mats
- Automotive Splash guards
- Pick-up Truck Bed Liners
- Brake Pedal Pads
- Counter Top Mats
- Trailer Wall Liner
- Sound Deadening
- Agricultural Mats

Tireplast/Thermo Plastic Mud Flaps

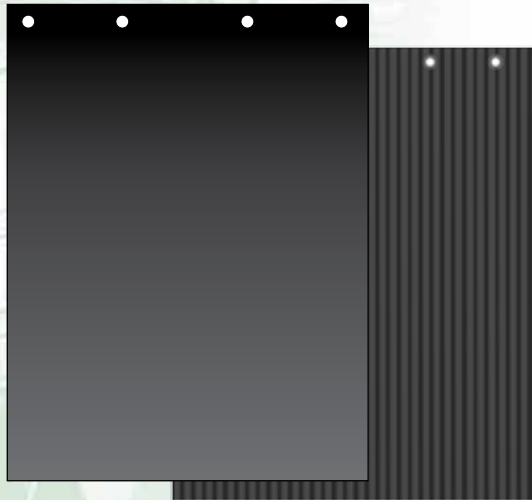

- Thermo plastic rubber
- Anti-curling attributes of a rubber flap
- Stiff anti-sail features of a poly flap
- Ribbed back for anti spray
- Also available in angle cut or rounded corners, Call our sales department for more information.



Tireplast Mud Flap Profile

Part Number	Description	Thickness
2424TPPSB	Tireplast Mud Flap - Black 24"x24"	1/4"
2430TPPSB	Tireplast Mud Flap - Black 24"x30"	1/4"
2436TPPSB	Tireplast Mud Flap - Black 24"x36"	1/4"
2424TPHDB	Heavy Duty Tireplast Mud Flap - Black 24"x24"	3/8"
2430TPHDB	Heavy Duty Tireplast Mud Flap - Black 24"x 30"	3/8"
2436TPHDB	Heavy Duty Tireplast Mud Flap - Black 24" x 36"	3/8"



3/16" Polyguard Standard

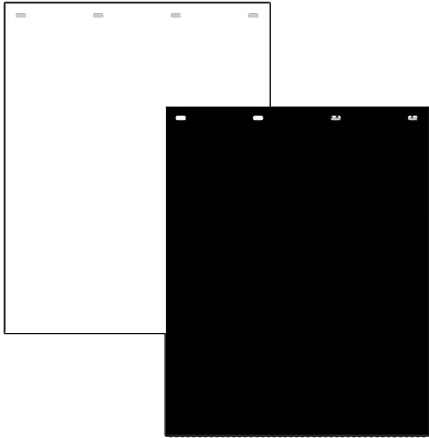

Part Number	Description	Weight Per Pair
2424PSB	24X24 Standard Poly - Black	
2424PSW	24X24 Standard Poly - White	6 lbs.
2430PSB	24x30 Standard Poly - Black	
2430PSW	24x30 Standard Poly - White	8 lbs.
2436PSB	24x36 Standard Poly - Black	
2436PSW	24x36 Standard Poly - White	10lbs.

Poly Standard Profile - Smooth Back

- 3/16" Thick
- Will not crack or curl
- Economic Price

1/4" Anti-Spray Poly Plus

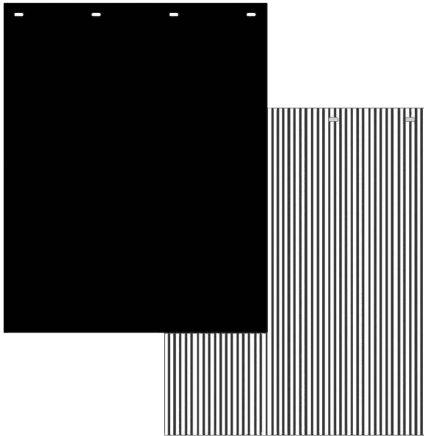

Part Number	Description	Weight Per Pair
2424PPSB	24X24 1/4" Anti-Spray - Black	
2424PPSW	24X24 1/4" Anti-Spray - White	7 lbs.
2430PPSB	24x30 1/4" Anti-Spray - Black	
2430PPSW	24x30 1/4" Anti-Spray - White	9 lbs.
2436PPSB	24x36 1/4" Anti-Spray - Black	
2436PPSW	24x36 1/4" Anti-Spray - White	11lbs.

Poly Plus Profile - Anti-Spray Back

- 1/4" Thick
- Anti-Spray Ribbed Back
- Medium Duty

3/8" Anti-Spray Poly Plus HD

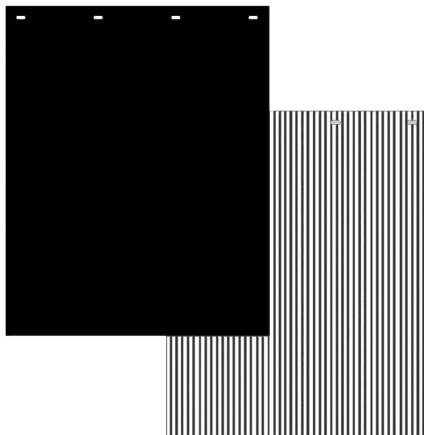

Part Number	Description	Weight Per Pair
2424PHDB	24X24 3/8" Anti-Spray - Black	
2424PHDW	24X24 3/8" Anti-Spray - White	10 lbs.
2430PHDB	24x30 3/8" Anti-Spray - Black	
2430PHDW	24x30 3/8" Anti-Spray - White	12 lbs.
2436PHDB	24x36 3/8" Anti-Spray - Black	
2436PHDW	24x36 3/8" Anti-Spray - White	14 lbs.

Poly HD Profile - Anti-Spray Back

- 3/8" Thick
- Anti-Spray Ribbed Back
- Heavy Duty



Silk-Screen Logo Rubber Mud Flaps



SILK-SCREEN LOGOS OFFER:

- Multi-Color logos with great detail!
- Long lasting urethane paint also used on floors and running tracks will **NOT WEAR OFF**
- Fast turn around

Mudflaps & Accessories





Polyguard Custom Logo Mud Flaps

Antispray Poly Mud Flaps Material Specification Sheet:

**Property
Material**

Tensile Strength
Tensile Elongation
Specific Gravity
Hardness, Shore D
Tear Resistance
Flexural Modulus
Notched Low Temperature Brittleness

ASTM Test Method Polyethylene	Value Polyethylene
D638	>4000 psi
D638	>1000%
D792	0.925
D2240	51
D1004	>1000 psi
D790	150,000 psi
D746	-42 C



HOT STAMPED LOGOS



Raised Molded Custom Logo Mud Flaps



Standard 5/16" Rubber Raised Molded

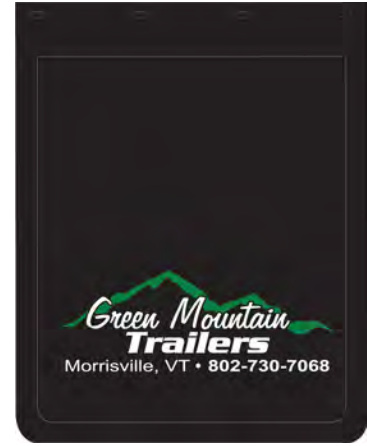

Part Number	Description	Weight Per Pair
GT-2418RSM	12" x 20" Standard 5/16" Rubber Raised Molded Custom Logo	6 lbs.
GT-2424RSM	19" x 24" Standard 5/16" Rubber Raised Molded Custom Logo	11 lbs.
GT-2430RSM	24" x 14" Standard 5/16" Rubber Raised Molded Custom Logo	11 lbs.
GT-2436RSM	24" x 18" Standard 5/16" Rubber Raised Molded Custom Logo	11 lbs.
GT-2442RSM	24" x 24" Standard 5/16" Rubber Raised Molded Custom Logo	13 lbs.
GT-2448RSM	24" x 30" Standard 5/16" Rubber Raised Molded Custom Logo	15 lbs.
GT-2454RSM	24" x 36" Standard 5/16" Rubber Raised Molded Custom Logo	17 lbs.



Heavy Duty 1/2" Rubber Raised Molded with Anti-Spray

Part Number	Description	Weight Per Pair
GT-2424HDRM	24" x 24" Heavy Duty 1/2" Rubber Raised Molded Custom Logo with Anti-Spray	19 lbs.
GT-2430HDRM	24" x 30" Heavy Duty 1/2" Rubber Raised Molded Custom Logo with Anti-Spray	22 lbs.
GT-2436HDRM	24" x 36" Heavy Duty 1/2" Rubber Raised Molded Custom Logo with Anti-Spray	24 lbs.
GT-2442HDRM	24" x 42" Heavy Duty 1/2" Rubber Raised Molded Custom Logo with Anti-Spray	26 lbs.



Raised Molded Custom Logo Mud Flaps



Rain Guard 3/8" Multi-Header Raised Molded with Anti-Spray

- Multi-Header Perfect for dump trucks, and off-road applications.
- Anti-Spray
- Anti-Sail
- Hole to Pin Flap Up to Avoid Tearing

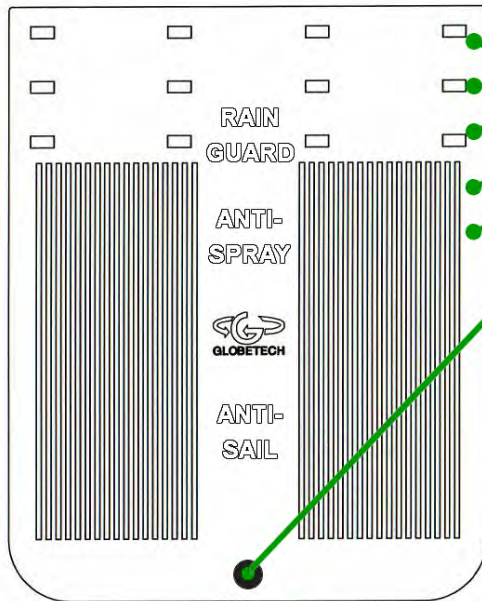

- Multi-Header
- Anti-Spray
- Anti-Sail
- Hole to Pin Flap Up to Avoid Tearing

Part Number	Description	Weight Per Pair
; H&(F; A	24" x 24" RainGuard 3/8" Rubber Raised Molded Custom Logo with Anti-Spray	14 lbs.
; H&' \$F; A	24" x 30" RainGuard 3/8" Rubber Raised Molded Custom Logo with Anti-Spray	15 lbs.
; H&' *F; A	24" x 36" RainGuard 3/8" Rubber Raised Molded Custom Logo with Anti-Spray	16 lbs.

All raised molded flaps are made in Dayton, Ohio USA.
 Our Flaps are made from 100% friction reinforced material to ensure ultimate tear strength and durability.













CUSTOM LOGO COLOR MUD FLAPS

MADE IN USA NOTE: Standard black and white available for all logo types.

Silkscreen
for rubber flaps

	Red - Pantone 185 C
	Blue - Pantone 2945 C
	Yellow - Pantone 115 C
	Green - Pantone 3298 C
	Orange - Pantone 1655 C
	Gray - P Cool Gray 5 C

Hot Stamp
for poly flaps

			
Red P 186 C	Blue P 2935 C	Dark Blue P 2965 C	Light Blue P 2925 C
			
Dark Green P 3435 C	Yellow P 116 C	Orange P 172 C	Maroon P 188 C
			Custom colors available \$100 charge per color (silkscreen & hotstamp)
Green P 348 C	Brown P 1615 C	Gray P Cool Gray 10 C	

Guidelines

RUBBER with SILKSCREEN LOGO

- Minimum order 50 each (25 pair)
- Lead time: New Logos 6-8 weeks
- Lead time: Existing logos 4-6 weeks
- Additional charge for multi-color

RUBBER with RAISED MOLDED LOGO

- Minimum order 300 each (150 pair)
- Lead time: 12-15 weeks
- \$300 SET-UP CHARGE 1 color only
- Additional charge for multi-color

POLY with HOT STAMP LOGO

- Minimum order 100 each (50 pair)
- Lead time: New Logos 6-8 weeks
- Lead time: Existing logos 4-6 weeks
- Additional charge for multi-color

Ordering - Call 937-274-5587 or Email PO to logos@gtmfginc.com with the following info:

- Type of flaps: Rubber, Poly, or Tireplast
- Flap Size and Flap Thickness
- Order Quantity
- Flap Color
- Imprint (Logo) Color(s)

Artwork - Original Adobe Illustrator (vector artwork) files preferred

*we can also use high resolution .jpg, .eps, .ai, .pdf, or .png or mailed in sample flap

Mudflaps & Accessories



2700 Needmore Rd. Ph: 937.274.5587
Dayton, OH 45401 Fax: 937.274.6102

MUDFLAP PROOF

Special Notes:

Customer: _____

Attn: _____

Flap Style: _____

Print Style: Hot Stamp Silkscreen

Flap Size: _____

Imprint
Color: _____

Order Qty: _____

Set-up Fee: _____

Approved By:

Signature: _____

Printed Name: _____

Date: _____

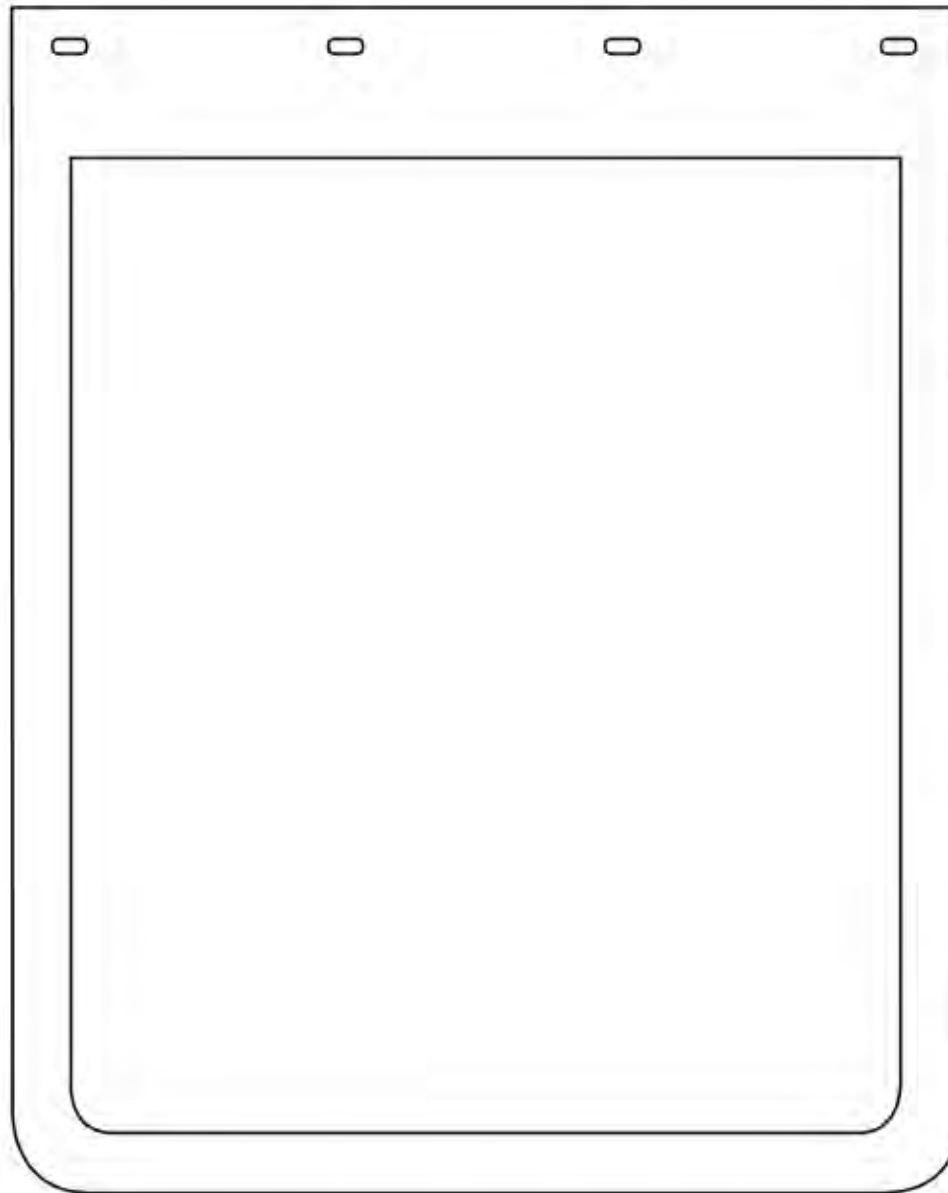

• Signed proof **MUST** be returned before production can begin!



Stock Raised Molded Rubber Mud Flaps



Part Number	Description
20x14WYO	20x14 Big Wonderful Wyoming Raised Molded Logo
24x30WYO	24x30 Big Wonderful Wyoming Raised Molded Logo
24x36WYO	24x36 Big Wonderful Wyoming Raised Molded Logo



Part Number	Description
12X18BIGSKY	12x18 Big Sky Montana Raised Molded Logo
20x14BIGSKY	20x14 Big Sky Montana Raised Molded Logo
24x14BIGSKY	24x14 Big Sky Montana Raised Molded Logo
24x30BIGSKY	24x30 Big Sky Montana Raised Molded Logo
24x36BIGSKY	24x36 Big Sky Montana Raised Molded Logo

Mudflaps & Accessories



Stock Logo Mud Flaps



GT-9026

GT-9021



GT-9020



GT-9014 = White Poly
GT-9015 = Black Poly
GT-9016 = Yellow Poly



GT-9017



GT-9032



GT-9019



GT-9023



GT-9024 - Black
GT-9025 - White



OHSA SPECIFIES:

1910.178(K) TRUCKS AND RAILROAD CARS

(1) The brakes of highway trucks shall be set and wheel chocks placed under the rear wheels to prevent the trucks from rolling while they are boarded with powered industrial trucks.



GT-2047D - Domestic HD Chock



- Large zinc-plated eyebolt
- Non-skid bottom
- 8"D x 10"L x 6"H

Replaces: Koneta 430030

GT-2048D - Domestic HD Chock



- Most popular design
- Zinc-plated eyebolt
- 9lbs.
- 8"D X 9-1/2"L X 5-3/4"H

GT-2049 - Contour Chock



- Molded handle on the back
- Nylon safety rope on request
- 11 pounds
- Used for heavy equipment and trucks

Replaces: Koneta 430040

GT-2050 - Standard Utility Chock



- Cored out back
- Power-coated handle
- 8 pounds
- Used by utility companies
- 8"D x 10"L x 5"H

GT-2052D - Recessed Stair Step Wheel Chock



- Recessed Zinc plated eyebolt
- Sharp steps to grip better
- 9 pounds
- 8"D x 9"L x 6"H

GT-2057 - Large Chock



- 16 pounds
- 10"D x 12"L x 8"H
- Used for off-road equipment and trucks



A52475 - Chock with Chain

GT-2047D wheel chock with chain assembly can be sold separate or attached to wheel chock.



Shark Skin Trailer Bumpers

**LAST
10X LONGER**

Globetech's 4-Layer Protection

- 2-Layers of abrasion resistant, high-tear strength compound
- 2-Layers of Styrene Butadiene encapsulated nylon cord sheets
- Base rubber compound consists of fiber reinforced prime rubber containing nylon and polyester
- Resists aging from weather, ozone, heat, abrasion and chemicals.

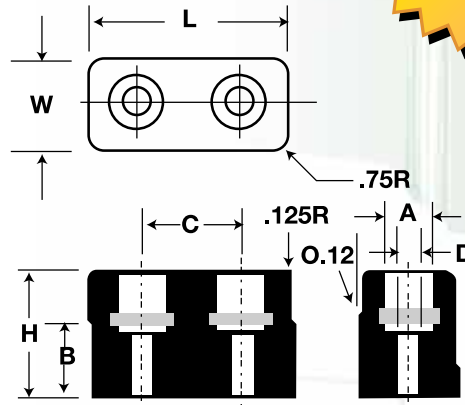

Part Number	A	B	C	D	L	W	H
GT-2000	1-1/2"	3-1/2"	3"	9/16"	6"	3"	5"
GT-2006	1-1/2"	1-3/4"	3"	9/16"	6"	3"	3-1/2"
GT-2312	1-3/8"	1-1/8"	2-5/8"	17/32"	6"	2-3/8"	3-1/4"
GT-2027	1-3/16"	1-3/4"	3-1/2"	11/16"	5-3/4"	3-3/4"	4-1/2"
GT-2042	1-1/4"	1"	4-5/8"	9/16"	7-7/8"	2-3/8"	2"
GT-2044	1-1/2"	1-1/4"	2-5/8"	17/32"	6"	2-3/4"	3"
GT-2345	1-7/16"	1-1/4"	3-1/2"	5/8"	6"	2-5/8"	3-1/4"
GT-UTM053	1-1/4"	3-1/2"	3-1/2"	17/32"	6-1/8"	3-5/8"	5-1/4"
GT-UTM172	1-1/4"	2-3/4"	3-1/2"	17/32"	6-1/8"	3-5/8"	4-1/2"
GT-UTM214	1-1/4"	1-3/4"	2-3/8"	1-7/32"	4-5/8"	2-5/8"	3-1/2"
GT-UTM259	1-1/4"	2-1/4"	3-1/2"	17/32"	6-1/8"	3-5/8"	4"
GT-UTM006	1-1/4"	1-3/4"	3-1/2"	17/32"	6-1/8"	3-5/8"	3-1/2"

Material Specifications:

- 80+5 Durometer
- Impact recovery (ASTM 1170) of 95%
- Tensile Strength 2000+ psi

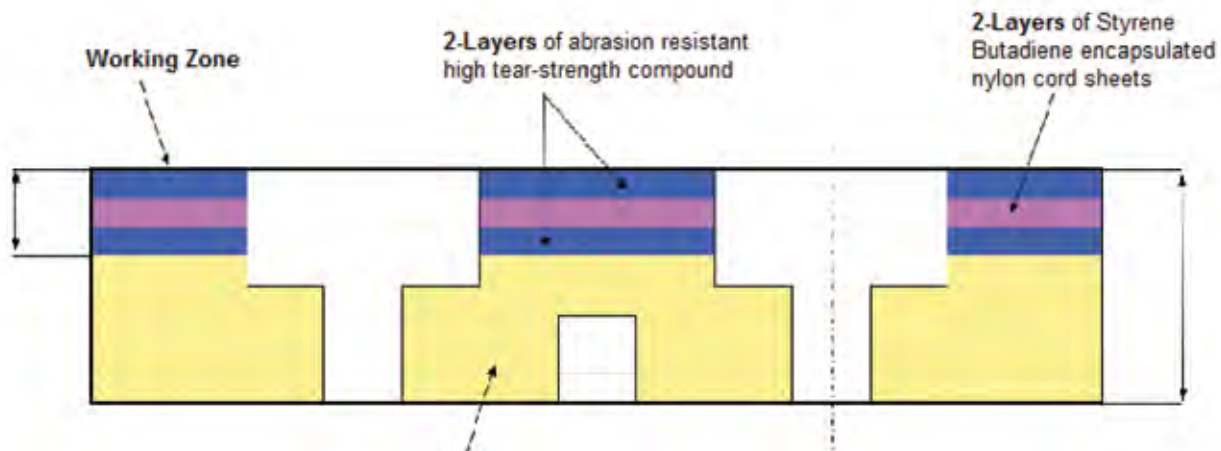



Shark Skin Trailer Bumpers



Globetech Manufacturing molded dock bumpers are the best in the industry. All bumpers are molded from fiber-reinforced rubber to ensure durability.

APPLICATIONS:

- Perfect protection for any high-traffic truck dock.
- In-plant wall protection from forklifts and other material-handling vehicles.

MATERIALS:

- Manufactured from fiber-reinforced prime rubber containing nylon and polyester.
- All bumpers have an impact recovery (ASTM 1170) of 95% with 80+ 5 durometer tensile strength.
- All molds have pre-drilled, countersunk mounting holes for easy installation and are drilled to accept 3/4" anchor bolts.

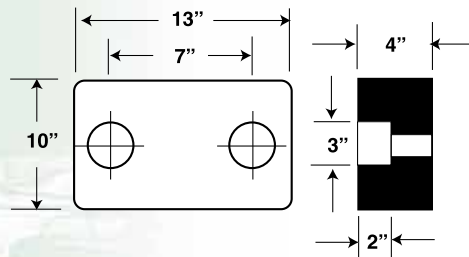

Part Number	Description	Weight
GT-2099	4" X 12" X 13"	21LBS.

Extruded Rubber Bumpers

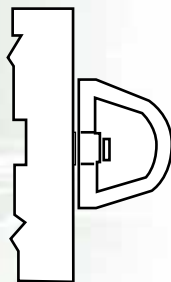

Extruded Rubber Bumpers

- Available up to 10 ft.
- For Live Stock Trailers
- Drilled holes

Part Number	Description	Weight
D-312	D-3 Dock Bumper 12" L x 3" W x 3" H	3 lbs.
D-324	D-3 Dock Bumper 24" L x 3" W x 3" H	6 lbs.
D-372	D-3 Dock Bumper 72" L x 3" W x 3" H	18 lbs.
D-412	D-4 Dock Bumper 12" L x 4" W x 4" H	6 lbs.
D-412A	D-4 Dock Bumper No Holes 24" L x 4" W x 4" H	6 lbs.
D-424	D-3 Dock Bumper 24" L x 4" W x 4" H	10lbs.
D-424A	D-4 Dock Bumper No Holes 24" L x 4" W x 4" H	10 lbs.
D-472	D-4 Dock Bumper 72" L x 4" W x 4" H	36 lbs.
D-612	D-6 Dock Bumper 12" L x 4" W x 6" H	9 lbs.
D-624	D-6 Dock Bumper 24" L x 4" W x 6" H	18lbs.
D-672	D-6 Dock Bumper 72" L x 4" W x 6" H	36lbs.

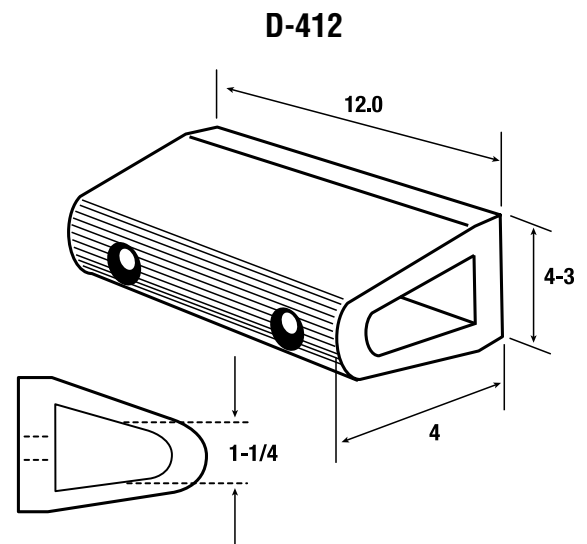

Mudflaps & Accessories



Shark Skin Trailer Bumpers



Standard Material

- Manufactured from fiber-reinforced prime rubber containing nylon & polyester
- 80+5 Durometer
- Impact recovery (ASTM 1170) of 95%
- Tensile strength = 2000+ psi
- Compression molded

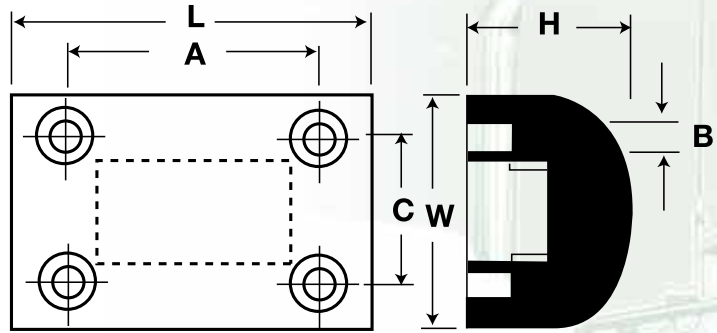

Part Number	A	B	C	L	W	H
GT-2036	5-1/2"	3/4"	3-1/4"	8"	5-1/4"	3-5/8"
GT-2045	5-1/2"	9/16"	3"	7-5/8"	5-1/2"	3-5/8"
GT-2046	5-3/8"	9/16"	3-1/8"	8"	6"	3"

Special Bumpers

Globetech can manufacture any custom molded bumper top any specification.

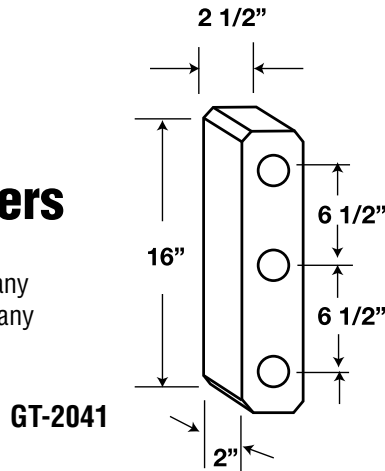

GT-2041

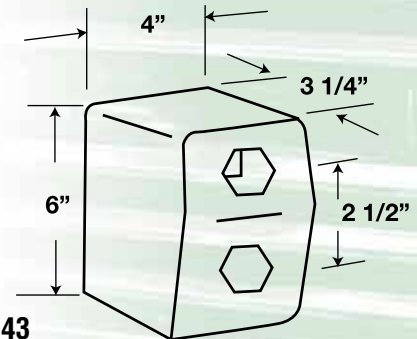

GT-2043

Part Number	Approx. Weight Each	Size
GT-2041	3lbs.	2" x 2" x 16"

Part Number	Approx. Weight Each	Size
GT-2043	3lbs.	6" x 4" x 3"



Laminated Bumpers

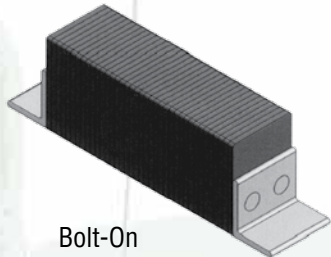

Bolt-On
GT-2100 = WAB21400170
GT-2105 = WAB21400177

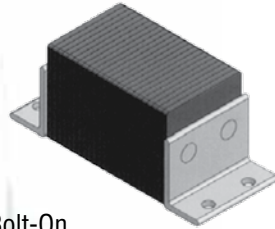

Bolt-On
GT-2101

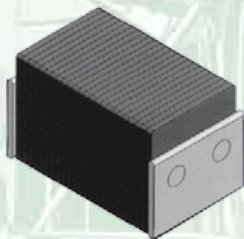

Weld-On
GT-2102

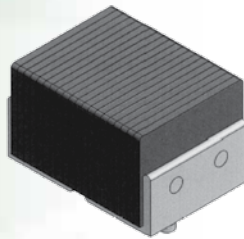

Weld-On
GT-2103

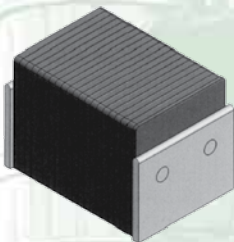

Weld-On
GT-2104

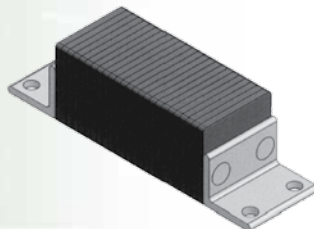

Weld-On
GT-2106

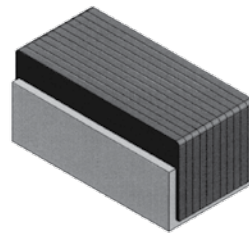

Stud Mount
GT-2107

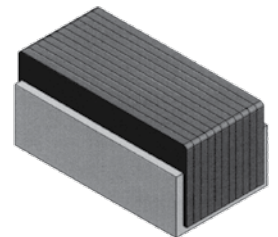

Stud Mount
GT-2109

- Stainless steel hardware
- Multi-ply belting
- Custom bumpers available

Part Number	Length	Width	Height
GT-2100	10-1/4"	3"	3-1/2"
GT-2101	6"	4"	4"
GT-2102	5-1/2"	4"	3"
GT-2103	5-1/2"	4"	3-1/4"
GT-2104	5-5/8"	4"	4"
GT-2105	9-1/2"	3"	4"
GT-2106	6-1/4"	2-7/8"	2-3/4"
GT-2107	6-1/8"	3-1/4"	2-3/4"
GT-2109	6"	2-3/4"	3"

Door Bumpers

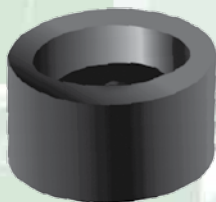

GT-025



GT-2108



GT-2613

- Made of SBR 60 Durometer

Part Number	Size	Hole Diameter
GT-025	1-7/8" x 1-5/8"	9/16"
GT-2108	1-1/2" x 3/4"	1/4"
GT-2613	2-1/2" x 1"	3/8"

Mudflaps & Accessories



Standard .640 Bar Type Mud Flap Hangers

The .640 square spring steel hangers are the standard for the trucking industry. Globetech mud flap hangers are manufactured and tested to OEM specs using SAE test methods. Our hangers are made to accomodate flaps of all sizes.

Kits include (2) mud flap hangers with adjustable flap clips, (2) GT-27B711 mounting brackets, (2) cotter pins and mounting hardware for flaps and brackets.

Part Number	Description	Cross Ref.	
		B23	031-00123
GT-2723B	Kit w/hardware, pair		



Part Number	Description	Cross Ref.	
		A25	034-00426
GT-2725A	Standard Straight Hanger 10/Box *hardware not included		
GT-2725B	Kit w/ hardware, pair	B25	031-00125
GT-2725B70	Bulk Barrel 70/ea *hardware not included	A25RLB40	031-0050



Part Number	Description	Cross Ref.	
		B33	031-00133
GT-2733B	Kit w/hardware, pair		



Part Number	Description	Cross Ref.	
		A35	034-00433
GT-2735A	Standard Angled Hanger 10/Box *hardware not included		
GT-2735B	Kit w/hardware, pair	B35	031-00135
GT-2735B40	Bulk Barrel 40/ea, *hardware not included	A35RLB40	031-00049



Part Number	Description	Cross Ref.	
		B29	031-00129
GT-2729B	Kit w/hardware, pair		

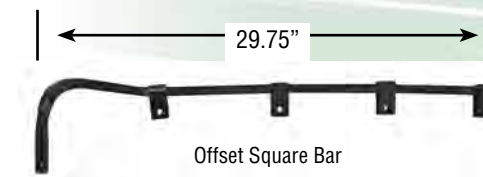



Mudflaps & Accessories

Globetech mudflap hangers and brackets are manufactured to the highest specifications to meet your needs.

Our mudflap hangers were tested by an independent lab and resulted in a superior rating for minimum permanent deflection.

Globetech mudflaps surpassed the Rockwell Hardness B testing per ASTM E18.

Heavy Duty .750 Bar Type Mud Flap Hanger

The .750 square spring steel hangers are among the strongest and most durable flap hangers on the market, designed to meet heavy load of anti-spray flaps. Globetech mud flap hangers are manufactured and tested to OEM specs using SAE test methods.



Kits include (2) mud flap hangers with adjustable flap clips, (2) GT-27B700 mounting brackets, (2) cotter pins and mounting hardware for flaps and brackets.



Straight HD Round Triple Coil

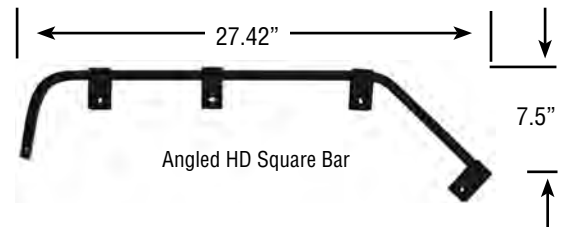

Angled HD Square Bar



Straight HD Square Bar



Straight HD Double Coil Square Bar

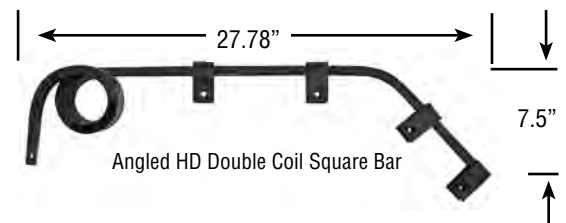

Angled HD Double Coil Square Bar

Part Number	Description	Cross Ref.
GT-2721B	Kit w/hardware, pair	B21 031-00121

Part Number	Description	Cross Ref.
GT-2781A	HD angled hanger 10/Box *hardware not included	A81 034-00685
GT-2781B	Kit w/hardware, pair	B81 031-00105

Part Number	Description	Cross Ref.
GT-2782A	HD straight hanger 10/Box *hardware not included	A82 034-00679
GT-2782B	Kit w/hardware, pair	B82 031-00102

Part Number	Description	Cross Ref.
GT-2783B	Kit w/hardware, pair	B83 031-00108

Part Number	Description	Cross Ref.
GT-2784B	Kit w/hardware, pair	B84 031-00110



Standard Mounting Brackets for .640 Hangers

- Cast steel construction
- Black primed finish
- Allows for relocation of brackets from one vehicle to another
- Kits include (2) brackets, (4) bolts w/lock washer, (4) nuts and (2) cotter pins

Part Number	Description	Cross Ref.
GT-27B711	Black cast mount bracket, single	B711
GT-27K711	Kit w/mounting hardware, pair	K711

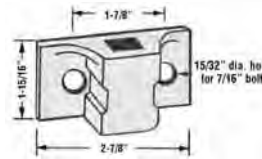

Heavy Duty Mounting Brackets for .750 Hangers

- Cast steel construction
- Black primed finish
- Allows for relocation of brackets from one vehicle to another
- Kits include (2) brackets, (4) bolts w/lock washer, (4) nuts and (2) cotter pins

Part Number	Description	Cross Ref.
GT-27B700	Black HD cast mount bracket, single	B700
GT-27K700	Kit w/mounting hardware, pair	K700

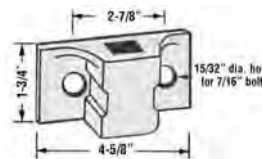

Standard Anti-Sail Bracket

- Assembly required
- Part number represents single bracket only - enough for one mud flap
- Fits standard 24.00" flaps
- Will accommodate flaps up to 3/8" thick

Part Number	Description	Weight	Cross Ref.
GT-2701SS	21" x 24" Anti-Sail Bracket Stainless Steel	1.82	033-05126
GT-2701C	21" x 24" Anti-Sail Bracket Chrome	1.82	033-05126



Standard Anti-Sail Bracket- One Piece Design

- Assembly required
- Part number represents single bracket only - enough for one mud flap
- Fits standard 24.00" flaps
- Will accommodate flap up to 1.00" thick

Part Number	Description	Weight	Cross Ref.
GT-2702SS	21" x 24" Anti-Sail Bracket One Piece Stainless Steel	1.82	033-00076
GT-2702C	21" x 24" Anti-Sail Bracket One Piece Chrome	1.82	033-00075





Mud Flap Mounting Angle & Retaining Strap

- .12" thick, heavy-duty steel construction
- Black primer finish



Part Number	Description	Weight	Cross Ref.	
GT-27051	2.00 x 2.00 x 27.50 mounting angle	3.4 lbs.	#07-50	033-00051
GT-27053	2.00 x 24.00 retaining strap	1.4 lbs.	#07-50-1	033-00053

Mud Flap Bolt Kit

- Attaches mud flaps to any type of mud flap bracket
- Sets consists of eight bolts, eight nuts, and sixteen washers
- Enough to hang two mud flaps
- Available in Stainless steel or Zinc options



Part Number	Description	Weight	Cross Ref.
GT-27516	Mud Flap Bolt Kit Stainless Steel packaged set	0.72	031-01200
GT-27517	Mud Flap Bolt Kit Zinc packaged set	0.72	031-01298



GT-2725A



GT-2735A

BULK DISPLAYS

Part Number	Description	Cross Ref.
GT-2725B70	Square Steel Straight Arm Hangers 70/ea- GT-2725A Bulk Barrel	A25RLB40
GT-2735B40	Square Steel Angled Down Hangers 40/ea-GT2735A Bulk Barrel	A35RLB40



Hardware
not included



Conspicuity Strips

- Durable Aluminum Plate
- Reflective tape meets FMVS standard
- Universal used either on roadside or curbside
- Can be used with any straight, shortie, bar or spring loaded bracket

Part Number	Description	Cross Ref.
GT-27RT25	Straight Aluminum Conspicuity Strips, pair	RT25
GT-27RT35	Angled Aluminum Conspicuity Strips, pair	RT35



Conspicuity Tape

- DOT-C2 certified, exceeds NHTSA requirements
- Highly reflective, even up to a 90° angle
- Available in red and white roll/strips, all white roll or all yellow roll
- Quick and easy to apply

Part Number	Description	Type
GT-27000	12" x 2" Strip (2)ea / 6" red x 6" white pattern	strip
GT-27003	150 feet / 6" red x 6" white pattern	roll
GT-27004	150 feet / 11" white x 7" red pattern	roll
GT-27005	150 feet all white tape	roll
GT-27006	150 feet all yellow tape	roll
GT-27007	150 feet all orange tape	roll



Plastic Reflective End Cap

- For use on all GT-27 Economy Brackets and many other brands
- Packaged set includes two reflective end caps and mudflap hardware

Part Number	Description	Cross Ref.
GT-27069	Plastic End Cap Packaged Set for GT-27 Economy Brackets	031-01269

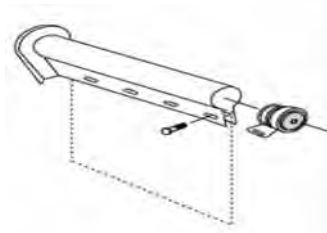



Economy Spring Loaded Brackets

Straight Tube Style Economy Bracket (replaces FB-27)

- Heavy-duty construction
- Design eliminates wind-caused bracket rotations
- Reduces flap and bracket damage
- Conforms to TTMA flap hole pattern
- Ideal for the heavy-duty spray suppression flaps



*Sets Include GT-27000
 • 12" x 2" Strip
 (2)ea / 6" red x 6" white pattern

Part Number	Description	Bolt Pattern	Replaces Fleet Engineers
GT-27270	28" Straight Arm Economy (Black E-Coat)-set	1.12"	033-00270
GT-27277	28" Straight Arm Economy (Stainless Steel)-set	1.12"	033-00277
GT-27868	30" Straight Arm Economy (Black E-Coat)-set	1.12"	033-00868
GT-27870	30" Straight Arm Economy (Stainless Steel)-set	1.12"	033-00870

Angled Down Tube Style Bracket (replaces FB-27)

- Heavy-duty steel construction
- Design eliminates wind-caused bracket rotations
- Reduces flap and bracket damage
- Conforms to TTMA flap hole pattern
- Ideal for the heavy-duty spray suppression flaps



*Sets Include GT-27000
 • 12" x 2" Strip
 (2)ea / 6" red x 6" white pattern

Part Number	Description	Bolt Pattern	Replaces Fleet Engineers
GT-27864	27" Angled Down Economy (Black E-Coat)-set	1.12"	033-00864
GT-27865	27" Angled Down Economy (Stainless Steel)-set	1.12"	033-00865
GT-27404	30" Angled Down Economy (Black E-Coat)-set	1.12"	033-03404
GT-27150	30" Angled Down Economy (Stainless Steel)-set	1.12"	033-04150

Mudflaps & Accessories



Heavy Duty Spring Loaded Brackets

Straight Arm HD Bracket (replaces Betts B57)

- Springs allow bracket to flex for extra durability
- Absorbs vibration, resists flap snags
- Springs allow bracket to flex for extra durability
- Works with any standard 24" wide flap
- Sets Includes two hangers w/reflective tape, and hardware



Part Number	Description	Bolt Pattern	Replaces Betts
GT-27B5728	28" Straight Arm HD (Black E-Coat) -set	1.18"	B5728
GT-27B5728SS	28" Straight Arm HD (Stainless Steel) -set	1.18"	B5728S
GT-27B57	30" Straight Arm HD (Black E-Coat) -set	1.18"	B57
GT-27B57SS	30" Straight Arm HD (Stainless Steel) -set	1.18"	B57S

*Sets Include GT-27000
 • 12" x 2" Strip
 (2)ea / 6" red x 6" white pattern

Angled Down HD Bracket (replaces Betts B67 & B68)

- Downward angle allows for mounting in tight spaces
- Absorbs vibration, resists flap snags
- Springs allow bracket to flex for extra durability
- Works with any standard 24" wide flap
- Sets Includes two hangers w/reflective tape, and hardware



Part Number	Description	Bolt Pattern	Replaces Betts
GT-27B6728	28" Angled Down HD (Black E-Coat) -set	1.18"	B672825
GT-27B6728SS	28" Angled Down HD (Stainless Steel) -set	1.18"	B672825S
GT-27B6728C	28" Angled Down HD (Chrome) -set	1.18"	B672825C
GT-27B67	30" Angled Down HD (Black E-Coat) -set	1.18"	B67
GT-27B67SS	30" Angled Down HD (Stainless Steel) -set	1.18"	B67S
GT-27B67C	30" Angled Down HD (Chrome) -set	1.18"	B67C
GT-27B68	30" Angled Down HD (Black E-Coat) -set	2.5"	B68
GT-27B68SS	30" Angled Down HD (Stainless Steel) -set	2.5"	B68S
GT-27B68C	30" Angled Down HD (Chrome) -set	2.5"	B68C

*Sets Include GT-27000
 • 12" x 2" Strip
 (2)ea / 6" red x 6" white pattern



Heavy Duty Spring Loaded Brackets

Tapered Arm HD Bracket (replaces Betts B7 & B71)

- Springs allow bracket to flex for extra durability
- Tapered design is extremely strong & efficient
- Works with any standard 24" wide flap
- Conspicuity strip not included



Part Number	Description	Bolt Pattern	Replaces Betts
GT-27B71	30" Straight Arm HD Tapered (Black E-Coat)-set	1.18"	B71
GT-27B71SS	30" Straight Arm HD Tapered (Stainless Steel)-set	1.18"	B71S
GT-27B71C	30" Straight Arm HD Tapered (Chrome)-set	1.18"	B71C
GT-27B7	30" Straight Arm HD Tapered (Black E-Coat)-set	2.5"	B7
GT-27B7SS	30" Straight Arm HD Tapered (Stainless Steel)-set	2.5"	B7S
GT-27B7C	30" Straight Arm HD Tapered (Chrome)-set	2.5"	B7C

High Visibility Light Bars With 4" Round Lights

- Stainless steel construction for durability
- Each stainless bar has 3 Pearl LED round lights
- Standard pigtailed included for easy installation
- Each bar measures 30" L x 6" W x 2.25" D
- Standard manufacturer's warranty included

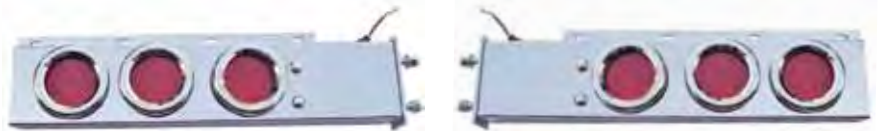

Part Number	Description	Cross Ref.
GT-27LT77S	L.E.D. Kit w/hardware, pair	LT77S

VISIT US ONLINE AT GTMANUFACTURING.COM

USA MANUFACTURING

OEM QUALITY TRAILER PARTS





Quarter Fender

Mounting Instructions

Recommended quarter fender mounting will result in maximum fender and top flap product life.

50-foot pounds of torque is needed on the steel clamp and 75-foot pounds of torque is needed on the stainless clamp. This torque is to be applied to the nut instead of the bolt. When this torque is applied, the flange end of the clamp should touch.

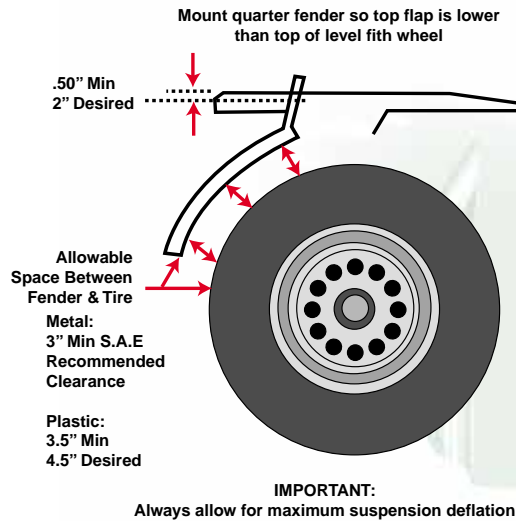

Braceless Standard Quarter Fender

- Durable 18 gauge formed metal
- Tube cradle support for added rigidity
- Mirror finish stainless steel
- Assembly required

Kit Includes:

- Two quarter fenders w/mounting hardware
- Two 24" rubber top flaps
- Top flap hardware
- Two clamps with 5/8" bolt and nut

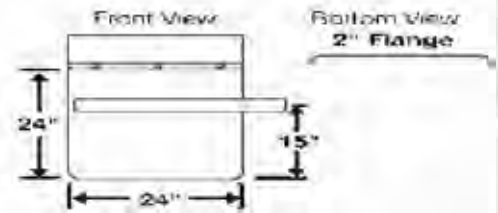

Part Number	Description	Replaces Fleetline	Weight
GT-39585B	Stainless Steel assembly, kit	1585B-Kit	29 lbs

Full Brace Standard Quarter Fender

- Durable 18 gauge formed metal
- Tube cradle support for added rigidity
- Mirror finish stainless steel
- Assembly required

Kit Includes:

- Two quarter fenders w/mounting hardware
- Two 24" rubber top flaps
- Top flap hardware
- Two clamps with 5/8" bolt and nut

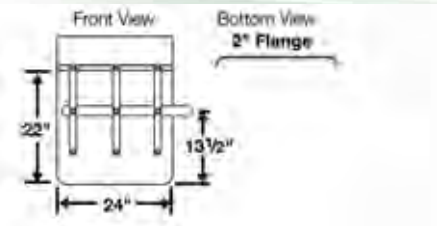

Part Number	Description	Replaces Fleetline	Weight
GT-39585FB	Stainless Steel assembly, kit	1585FB-Kit	32 lbs



Half Brace Standard Quarter Fender

- Durable 18 gauge formed metal
- Tube cradle support for added rigidity
- Assembly required
- Mirror finish stainless steel



Kit Includes:

- Two quarter fenders w/mounting hardware
- Two 24" rubber top flaps
- Top flap hardware
- Two clamps with 5/8" bolt and nut

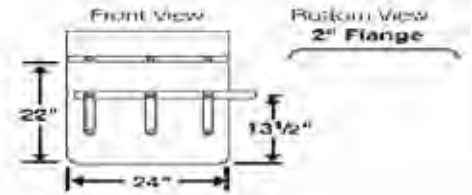

Part Number	Description	Replaces Fleetline	Weight
GT-39585HB	Stainless Steel assembly, kit	1585hb-Kit	30 lbs

Low Mount Standard Quarter Fender

- Durable 18 gauge formed metal
- Tube cradle support for added rigidity
- Mirror finish stainless steel
- Assembly required



Kit Includes:

- Two quarter fenders w/mounting hardware
- Two 24" rubber top flaps
- Top flap hardware
- Two clamps with 5/8" bolt and nut

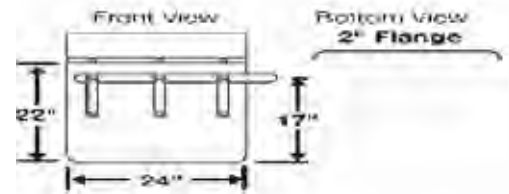

Part Number	Description	Replaces Fleetline	Weight
GT-39585LM	Stainless Steel assembly, kit	1585LM-Kit	29 lbs

Braceless Poly Quarter Fender

- Extreme Weather Polyethylene construction
- Guaranteed not to chip, crack or break
- Molded tube cradle for added rigidity
- Tested to -100°F without failure
- Assembly required



Kit Includes:

- Two quarter fenders w/mounting hardware
- Two 24" black poly top flaps
- Top flap hardware
- Two clamps with 5/8" bolt and nut

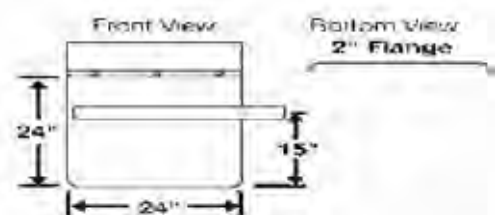

Part Number	Description	Replaces Fleetline	Weight
GT-3900-L	Black Poly assembly, Left	1900-L	10 lbs
GT-3900-R	Black Poly assembly, Right	1900-R	10 lbs
GT-3900	Black Poly assembly, Pair	1900-KIT	20 lbs



Quarter Fender Top Flaps

- Durable Black or White polyethylene and black rubber options
- Custom flaps available with company logo
- Top flap hardware not included

Part Number	Description	Weight
GT-2406	Black Rubber Plain, single	1.0 lbs.
2406PSB	Black Poly Plain, single	0.5 lbs.
2406PSW	White Poly Plain, single	0.5 lbs.



GT-2406

Part Number	Description	Weight
2605PSB	Black Poly Plain, single	0.5 lbs.
2605PSW	White Poly Plain, single	0.5 lbs.



Top Flap Hardware

- For use with plain or custom logo flaps
- Available in stainless or zinc plated steel and black nylon
- Includes eight nuts, eight bolts, and eight washers in a Globetech bag

Part Number	Description	Weight
GT-39414	Zinc Plated Steel Hardware, packaged set	0.3 lbs.
GT-39415	Stainless Steel Hardware, packaged set	0.3 lbs.
GT-39416	Black Nylon Hardware, packaged set	0.2 lbs.





Quarter Fender Mount Tube

- Stainless Steel or Black E-Coat construction
- Must be used with post, side mount socket or 50" cross tube
- Includes 2" end cap
- Does not include clamp or hardware

Part Number	Description	Weight	Cross Ref.
GT-391625	27" Stainless steel pipe with end cap	2.5 lbs.	30 lbs
GT-391626	27" black E-Coat pipe with end cap	2.5 lbs.	30 lbs



Quarter Fender End Caps

- Available in Stainless Steel or Black Plastic
- 2" Diameter

Part Number	Description	Weight	Cross Ref.
GT-391300	Stainless steel 2" end cap, (set)	.2 lbs.	1300-3A
GT-391301	black plastic 2" end cap, (set)	.2 lbs.	



*Sets packaged in Globetech bag

Quarter Fender Clamps

- Available in Stainless Steel or Black E-Coat
- Sets includes two clamps with 5/8" bolt/nuts

Part Number	Description	Weight	Cross Ref.
GT-391585	Stainless Steel 2" Fender Clamp w/hardware (set)	.5 lbs.	1585-8WHA
GT-391590	Black E-Coat 2" Fender Clamp w/hardware (set)	.2 lbs.	1590-8WHA





Post Mount Socket

- Cast steel construction Black primer finish
- For independent post mounting
- Bolts directly to frame or suspension using present vehicle hardware
- 8.00" for added strength and durability

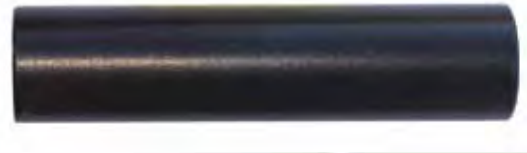

Part Number	Description	Weight	Cross Ref.
GT-391600	8" Stub Post Mount, single	3 lbs.	1600-15M



Post Mount Socket With Flange

- Steel construction Black E-Coat finish
- For independent side mounting
- Bolts directly to frame using present vehicle hardware
- Mounting plate 3.75" x 3.75"

Part Number	Description	Weight	Cross Ref.
GT-391601	8" Stub Post Mount with Flange, single	6 lbs.	1600-11M



Cross-Mount Tube Kit

- Steel construction Black primer finish
- For heavy-duty, over-the-frame mounting 50.00" long for added strength and durability
- Bulk kit contains one cross mount tube and all mounting hardware
- Hardware packaged set consists of mounting brackets , u-bolts, and nuts

Part Number	Description	Bar Length	Cross Ref.
GT-395000	50.00" Cross Mount Kit, including U-bolt Clamp Assembly	50.00"	555000

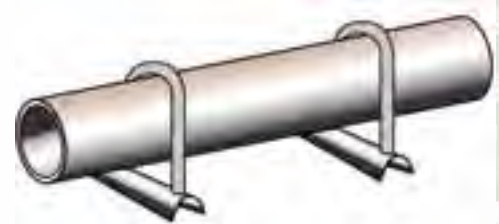

Cross-Mount Tube Hardware

- Two U-Bolts with brackets
- Four nuts
- Four washers

Part Number	Description	Weight	Cross Ref.
GT-395001	U-bolt Clamp Assembly Kit	1 lbs.	1580-12





QUICK REFERENCE GUIDE

Standard .640 Bar



GT-2723B



GT-2725B



GT-2733B



GT-2735B



GT-2729B

Heavy Duty .750 Bar



GT-2721B



GT-2781B



GT-2782B



GT-2783B



GT-2784B

Spring Loaded



GT-27270



GT-27865



GT-27B6728



GT-27B57SS



GT-27B68



GT-27B7SS



GT-27LT77S



GT-2725B70



GT-2735B40

Conspicuity Strips



GT-27RT25



GT-27RT35

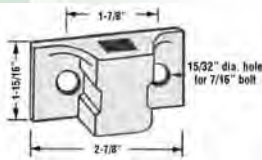

GT-27B711

Plastic Reflective End Cap



GT-27069

Anti-Sail Bracket

GT-2701SS



BULK DISPLAYS



GT-2725B70

GT-2735B40

Hardware Kit



GT-27516

Mudflaps & Accessories

Conspicuity Strips



GT-27RT25



GT-27RT35

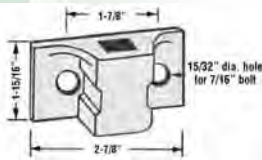

GT-27B711

Plastic Reflective End Cap



GT-27069

Anti-Sail Bracket

GT-2701SS



BULK DISPLAYS



GT-2725B70

GT-2735B40

Hardware Kit



GT-27516



ABS Cable

THE FAT CABLE

- More Copper
- More Tubing

EXCEEDS SAE J2222 Standard

Sealed Screw



- Excellent coil memory and durability.
- Flexible in temperatures to -85°F (-65°C).
- Resistant to gasoline, diesel fuel, ultraviolet and commonly encountered chemicals.
- Up to 5 times more abrasion-resistant than competing cables.
- Durable die-cast plugs are standard.
- "T-Grip" resists breakage.
- 1/8, 2/10, 4/12 gauge.

ABS Coil Assemblies 1/8, 2/10, 4/12 Gauge

Part Number	Length	Description	Replaces Tectran	Replaces Sloan
GT-3300	12'	2 x 12" Lead	7ATG222MG	590160
GT-3301	15'	2 x 12" Lead	7ATG522MG	590161
GT-3302	15'	1-12" Lead	7ATG542MG	590163
		1-40" Lead		
GT-3303	20'	2 x 12" Lead	7ATG6222MG	590080
GT-3304	20'	1-12" Lead	7ATG642MW	590081
		1-40" Lead		

ABS Straight Assemblies 1/8, 2/10, 4/12 Gauge

Part Number	Length	Replaces Tectran	Replaces Sloan
GT-3306	12'	7AAB122MG	421166
GT-3307	15'	7AAB152MG	421167
GT-3308	20'	7AAB202MG	421247



all references to competitors' part numbers are for cross reference purposes only



Standard Duty Cables Non ABS Seven-Way Straight Cable Assemblies

GT-3310 – Non ABS

- 15/ft. Long 12” standard lead
- Flexible from - 60°F to 150°F
- Metal zinc connectors 6/14 - 1/12” gauge



Part Number	Length	Description	Replaces Tectran	Replaces Sloan
GT-3309	12”	2 x 12” Lead	7ETB222MG	421010
GT-3310	15”	2 x 12” Lead	7ETB522MG	42113
GT-3311	15”	1-12” Lead 1-48” Lead	7ETB542MG	421180

- All length and leads are available upon request.

Standard Duty Cables Non ABS Seven-Way Straight Assemblies

- Heavy-Duty zinc die cast plugs with spring guards included. 6/14 - 1/12” gauge

Part Number	Length	Replaces Tectran	Replaces Sloan
GT-3315	12”	7SAB122MG	421164
GT-3316	15”	7SAB152MG	421165

- All length and leads are available upon request.





Six-Way Coiled Cable Assembly

- 12' working length
- Durable black outer jacket resists abrasion and has excellent coil memory.
- Heavy-Duty zinc die cast plugs with spring guards included.

Part No.	Length	Description	Replaces Tectran	Replaces Sloan
GT-3317	12"	6 Conductor / 14 gauge	7R6122M	421165



Single Pole Coiled Assembly

For applications where cables are used to charge trailer lift gate batteries.

Jacket Color: Green

- 200 amp max for international lift gate applications at 12 VDC
- 110 amp max for continuous applications at 12 VDC
- Heavy-Duty zinc die cast plugs with spring guards included
- External ground option
- 4 gauge cable

Part No.	Length	Description	Replaces Tectran	Replaces Sloan
GT-3324	12"	Tailgate lift battery, 4 gauge	7BTG222MG	421145
GT-3325	15"	Tailgate lift battery, 4 gauge	7BTG522MG	421146

Two Pole Coiled Assembly

- Rated at 200 amps for lift gate applications at 12 VDC
- 4 gauge cable
- Internally grounded
- Withstand temperatures of -85° to + 185° F
- Durable black polyethylene outer jacket resists abrasions and chemical damage while offering excellent coil retention
- Heavy-Duty zinc die cast plugs with spring guards included

Part No.	Length	Description	Replaces Tectran	Replaces Sloan
GT-3326	12"	Two pole, 4 gauge	7DTB222MW	421172
GT-3327	15"	Two pole, 4 gauge	7DTB522MW	421173



Plugs



GT-3001



GT-3001G



GT-3002



GT-3004



GT-3005



GT-3006A



GT-3007B



GT-3007D



GT-3007Y



GT-3007YD

A = no spring B = with spring D = blade G = ground kit Y = plastic

Part Number	Description	Replaces Phillips	Replaces Sloan
GT-3001	1-pole plug w/spring, double grip, die cast	15-335	--
GT-3001G	1-pole plug w/spring & ground kit, double grip, die cast	15-335	--
GT-3002	2-pole plug w/spring, double grip, die cast	15-336	--
GT-3004	4-pole plug w/spring, die cast	15-430	421131
GT-3005	5-pole plug, die cast housing, chrome-plated		421133
GT-3006A	6-pole plug, no spring, die cast	15-610	421135
GT-3006B	6-pole plug w/spring, die cast	15-630	421122
GT-3007A	7-pole plug, no spring, die cast	15-710	421000
GT-3007B	7-pole plug w/spring, die cast	15-730	421001
GT-3007D	7-pole plug, blade style, car end only housing & cover (zinc)	16-713	--
GT-3007E	7-pole plug w/spring, economy, die cast	15-730	4210 01
GT-3007Y	7-pole plug, nylon	--	421147
GT-3007YD	7-pole plug, blade style, car end only ABS housing (plastic)	16-714	--



Sockets



GT-3010G



GT-3012



GT-3014



GT-3015



GT-3016



GT-3227



GT-3227D



GT-3227MZ



GT-3227YD



GT-3338



GT-3338K

A = no spring B = with spring D = blade G = ground kit Y = plastic

Part Number	Description	Replaces Phillips No.	Replaces Sloan
GT-3010	single pole socket, die cast	15-320	421126
GT-3010G	single pole socket w/ground kit, die cast	15-320	--
GT-3012	dual pole socket, die cast	15-326	421171
GT-3014	4-pole socket, split pin, die cast	15-400	421132
GT-3015	5-pole socket, die cast housing, chrome-plated	--	421134
GT-3016	6-pole socket, split pin, die cast	15-600	421136
GT-3227	7-pole socket, Pollack style, die cast	15-720	421015
GT-3227D	7-pole socket, blade style, car end only housing & cover (zinc)	16-714	--
GT-3227MB	bracket for 7-pole connector, black E-coated	15-788	--
GT-3227MZ	bracket for 7-pole connector, zinc-plated	15-788	--
GT-3227E	7-pole socket, economy style, die cast	15-720	421015
GT-3227SP	7-pole socket, solid pin, die cast	15-721	421124
GT-3227YD	7-pole socket, blade style, car end only ABS housing & cover (plastic)	16-713	--
GT-3337	7-way base, solid diecast EZ-7 style		--
GT-3338	7-way nylon socket w/gasket split pin	(Replaces Tramec 38502W)	
GT-3338G	gasket only, for GT-3338 socket		
GT-3338K	lid kit for GT-3338 socket nylon	(Replaces Tramec 38502W)	



Connectors and Junction Boxes



GT-3612



GT-3613



GT-3614



GT-3614-2



GT-3615



GT-3616



GT-3624

Part Number	Description
GT-3612	2-pole flat connector, 18G wire, 12" loop
GT-3613	3-pole flat connector, 18G wire, 12" loop
GT-3614	4-pole flat connector, 18G bonded wire, 12" loop
GT-3614-2	4-pole flat connector, 18G wire, 24" loop
GT-3624	4-pole flat connector, 18G bonded wire, 12" loop, shrouded
GT-3615	5-pole flat connector, 18G bonded wire, 12" loop
GT-3616	6-pole square connector, 18G wire, 12" loop, shrouded

Electrical Junction Box

7- way Junction Box

- Box is made of high impact black UV resistant ABS plastic
- Sealing surface of lid has a unique V groove to help prohibit moisture entry
- Seven #10-32 studs supplied with nuts and lock washers
- Supplied with five grommets and two strain relief clamps
- Mounting hole centers - 7 3/8"
- Terminal connectors are coded for easy identification
- Kit includes both open and closed grommets, star washers and nuts.



Part Number	Description	Replaces Tectran
GT-3100	Standard junction box	667-7040
GT-3101	Junction box with bracket	667-7050



Adapters and Protector Boots



GT-3604YD



GT-3607



GT-3706



GT-3707YD



GT-3704YD



GT-3714



GT-3715



GT-3715W

D = Blade Y = Plastic

Part Number	Description
GT-3604YD	6 to 4 way adapter, 6-way pole to 4-way flat, plastic
GT-3607	6 to 7 way adapter
GT-3704YD	7 to 4 way adapter, flat style, 7 pole round to 4 pole flat, plastic
GT-3706	7 to 6 way adapter
GT-3707YD	7 to 7 way adapter, 7 way pole to 7 way blade, plastic
GT-3714	7 to 4 way adapter, 7 way round to 4 way flat inline female w/cover
GT-3715	7 to 5 way adapter, 7 way blade to 5 way flat inline female
GT-3715W	7 to 5 way adapter, 7 way blade to 5 way flat inline female 2 ft wire



GT-3200



GT-3202

Part Number	Description	Replaces Phillips
GT-3200	Electrical plug protector boot fits GT-3227, GT-3227E, and GT-3227SP	15-740
GT-3202	Electrical socket protector boot 2" x 3" hole mount	



Rubber Cushion Clamp



Part Number	Width	Clamping DIA.	Screw Size	Replaces Phillips
GT-35044	1/2"	1/4"	1/4"	5-45044
GT-35064	1/2"	3/8"	1/4"	5-45064
GT-35084	1/2"	1/2"	1/4"	5-45084
GT-35104	1/2"	5/8"	1/4"	5-45104
GT-35124	1/2"	3/4"	1/4"	5-45124
GT-35154	1/2"	1"	1/4"	5-45164
GT-36044	5/8"	1/4"	3/8"	5-46044
GT-36064	5/8"	3/8"	3/8"	5-46064
GT-36084	5/8"	1/2"	3/8"	5-46084
GT-36104	5/8"	5/8"	3/8"	5-46104
GT-36124	5/8"	3/4"	3/8"	5-46124
GT-36164	5/8"	1"	3/8"	5-46164
GT-36241	5/8"	1-1/4"	3/8"	5-46241
GT-36271	5/8"	1-1/2"	3/8"	5-46271
GT-36281	5/8"	2"	3/8"	5-46281
GT-36291	5/8"	2-1/2"	3/8"	5-46291
GT-36301	5/8"	3"	3/8"	5-46301
GT-36302	5/8"	4"	3/8"	--
GT-36304	5/8"	5"	3/8"	--

Wire Clip

Plastisol dipped coating



Part Number	Description	Replaces Wabash
GT-3402	Small Wire Clip	2120046
GT-3403	Large wire clip	2120005

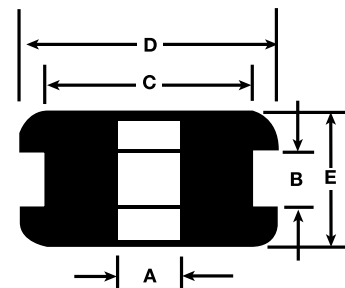

Rubber Grommet



Part No.	A Inside Diameter	B Groove Width	C Drill Diameter	D Outside Diameter	E Overall Thickness
GT-7710	5/16"	1/16"	7/16"	9/16"	3/16"
GT-7711	1/2"	1/4"	1"	1-3/8"	1/2"
GT-7712	3/5"	1/8"	24/25"	1-1/4"	6/16"
GT-7713	21/29"	1/5"	1-3/16"	1-3/4"	1/2"

Electrical



Zinc Die-Cast 7-Way Socketbreakers

- Heavy-Duty die-cast material
- 2 Hole mount with gasket included
- 7 pole, split-pin with a full-open lid
- available with metal or nylon circuit breakers.



GT-3017-G



BACK



FRONT

Part Number	Description	Replaces Grote	Pack Size
GT-3017-15	15 amp, metal breakers, split pin	82-0854	1
GT-3017-20	20 amp, metal breakers, split pin	82-0855	1
GT-3017-20K	20 amp, metal breakers, split pin, with nosebox & gasket	82-0850	1 (kit)
GT-3017-30	30 amp, metal breakers, split pin	82-0856	1
GT-3017-15P	15 amp nylon breakers, split pin	--	1
GT-3017-20P	20 amp, nylon breakers, split pin	82-0857	1
GT-3017-30P	30 amp, nylon breakers, split pin	82-0858	1
GT-3017-	No circuit breakers, split pin	82-0853	1

Poly Split Looms

100 Foot Rolls

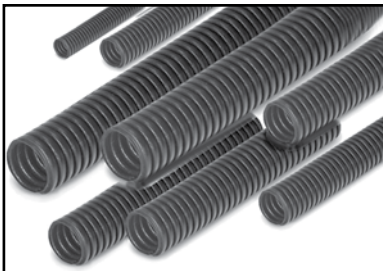

Part Number	Description
GT-3801	1/4"
GT-3802	3/8"
GT-3803	3/8"
GT-3803-R	red, 1/2"
GT-3803-G	gray, 1/2"
GT-3804	5/8"

Part Number	Description
GT-3805	3/4"
GT-3806	1"
GT-3807	1-1/4"
GT-3808	1-1/2"
GT-3809	1-7/8"
GT-3810	2"



Circuit Breakers and Switches

Circuit Breakers

Part Number	Description	Replaces Tectran	
GT-3550	15 amp circuit breaker metal	660-15	M e t a l
GT-3551	20 amp circuit breaker metal	660-20	
GT-3552	25 amp circuit breaker metal	660-25	
GT-3553	30 amp circuit breaker metal	660-30	
GT-3550P	15 amp circuit breaker plastic	661-15	P l a s t i c
GT-3551P	20 amp circuit breaker plastic	661-20	
GT-3552P	25 amp circuit breaker plastic	661-25	
GT-3553P	30 amp circuit breaker plastic	661-30	



Ground Kits

Part Number	Description
GT-3400	Ground kit



Ground Strap



Part Number	Description
GT-3401	Ground strap, 12" 4 ga

Brush Kit

GT-3201

Male & Female
Cleaning kit for 7-way plugs and sockets

Replaces: Tectran 5031





Electrical Connectors

Zinc Die-Cast Deep Nosebox

- 55% more interior space than the GT-3203.
- Larger interior space allows for easier access & maintenance.
- 3-1/8" deep.
- Fits 15 series and 16 series socketbreakers.
- Standard hole pattern.
- Kit includes gasket, grommet and socketbreaker mounting hardware.
- Does not include nosebox mounting hardware.



GT-3204
Deep Nosebox Kit

Part Number	Description	Replaces Phillips
GT-3203	Zinc die-cast nosebox kit	15-769
GT-3203-G	Gasket for nosebox	15-767
GT-3203-D	Grommet for nosebox	15-765
GT-3204	Zinc die-cast deep nosebox kit	15-775
GT-3204-G	Gasket for deep nosebox	--
GT-3204-D	Double grommet for deep nosebox	--
GT-3017-G	Gasket for socketbreaker	15-766

GT-3203 Standard Nosebox

- 1 7/8" deep.
- For use with 15 series or 16 series socketbreakers.
- Kit includes gasket, grommet and socketbreaker mounting hardware.
- Does not include nosebox mounting hardware.

GT-3204-D
Double
Grommet



GT-3203
Standard Nose Box Kit

Nylon Deep Nosebox

- 55% more interior space than the GT-3203.
- Larger interior space allows for easier access & maintenance.
- 3-1/8" deep.
- Fits 15 series and 16 series socketbreakers.
- Standard hole pattern.
- Kit includes gasket, grommet and socketbreaker mounting hardware.
- Does not include nosebox mounting hardware.



GT-3205
Nylon Deep Nosebox Kit





Rubber Tractor Lamps

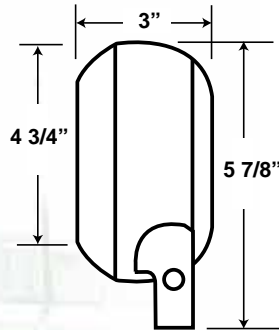

- 4-3/8” round housing with swivel base
- Sealed beam
- Par 36
- 12v 55w halogen bulb

Part Number	Description	Replaces
GT-7450	Rubber tractor lamp	TL80360

License Plate Lights

Part Number	Description	Replaces
GT-7460	License plate light, zinc-plated	TL26330
GT-7461	License plate light, chrome-plated	



**GLOBETECH
MANUFACTURING, INC.**





Visit our website for discontinued/overstock parts availability
www.gtmanufacturing.com/discontinued-overstock-parts

Electrical



GT-4009 Series Hub Caps 380 Aluminum Alloy

G - Dirt exclusion grease hub cap
S - Side fill for oil
H- Hubodometer with side fill
K- Includes gasket

Part Number	Size	Gasket	Window Kit	Replaces									
 GT-4009 Standard hub cap without side fill *Does not Include gasket <hr/> GT-4009K Standard hub cap without side fill *Includes gasket	<ul style="list-style-type: none"> • NO. Bolts 6 • Bolt Circle: 5.5" • Bolt Size: 5/16" • Overall Depth: 2-11/16" • Inside Depth: 1-15/16" • Flange I.D.: 4-3/8" • Flange O.D.: 6-1/4" 	GT-4006	GT-4003	STEMCO 340-4009									
 GT-4009G Dirt exclusion grease hub cap *Does not include gasket					GT-4006	GT-4000	STEMCO 342-4009						
 GT-4009S Standard hub cap with side fill *Does not include gasket <hr/> GT-4009SK Standard hub cap with side fill *Includes Gasket								GT-4006	GT-4003	STEMCO 343-4009			
 GT-4009H Hubodometer hub cap with side fill *Does not include gasket											GT-4006	GT-4002	STEMCO 347-4009

Test Procedure: Sample preparation and chemical analysis were conducted in accordance with standard laboratory procedures. Hardness testing was conducted in accordance with ASTM E18-03.

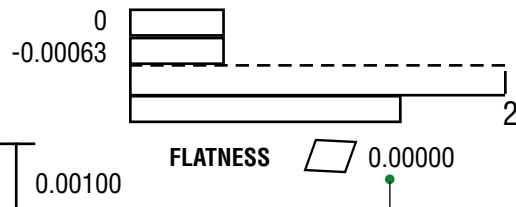

Flatness: 0.00163
Number of points 14

All Globtech Hub Caps
test less than .002
flatness

Test Results:

Chemical Analysis (percentage)	
Manganese	0.16
Silicon	8.68
Nickel	0.08
Chromium	0.04
Copper	3.06
Aluminum	0.04
Magnesium	0.07
Iron	1.06
Titanium	0.03
Zinc	1.18
Tin	0.02
Material Included:	380 Aluminum Alloy
Mechanical Properties	
Hardness	HRB 45



Globetech's standard hub caps are die-cast from a 380 aluminum alloy. They resist cracking, warping and breaking in any conditions.

- Each hub cap is individually poly-bagged.
- Vent plug is molded in a nitrile rubber.
- Dow Corning CALIBRE lens, UV-stabilized.

G - Dirt exclusion grease hub cap

S - Side fill for oil

H- Hubodometer with side fill

K- Includes gasket

Part Number		Size	Gasket	Window Kit	Replaces
 GT-4007F	GT-4007 Stamped Steel without filler vent	<ul style="list-style-type: none"> • NO. Bolts: 6 • Bolt Circle: 4.5" • Bolt Size: 5/16" • Overall Depth: 2 • Inside Depth: 1-15/16" • Flange I.D.: 3-5/16" • Flange O.D.: 5-3/16" 	GT-4006	N/A	STEMCO 340-5097
	GT-4007F Stamped Steel with filler vent				STEMCO 340-5096
Part Number		Size	Gasket	Window Kit	Replaces
 GT-4013	GT-4013 Hub cap without side fill *Does not include gasket	<ul style="list-style-type: none"> • NO. Bolts 5 • Bolt Circle: 5.5" • Bolt Size: 5/16" • Overall Depth: 2-11/16" • Inside Depth: 1-15/16" • Flange I.D. : 4-3/8" • Flange O.D.: 6-1/4" 	GT-4004	GT-4003	STEMCO 340-4013
Part Number		Size	Gasket	Window Kit	Replaces
 GT-4024	GT-4024 Hub cap without side fill *Does not include gasket	<ul style="list-style-type: none"> • NO. Bolts: 6 • Bolt Circle: 4.5" • Bolt Size: 5/16" • Overall Depth: 2-5/8" • Inside Depth: 1-7/8" • Flange I.D.: 3-1/2" • Flange O.D.: 5-1/4" 	GT-4025	GT-4005	STEMCO 340-4024
	GT-4024S Hub cap with side fill *Does not include gasket			GT-4005	STEMCO 343-4024
Part Number		Size	Gasket	Window Kit	Replaces
 GT-4195	GT-4195 Hub cap without side fill *Does not include gasket	<ul style="list-style-type: none"> • NO. Bolts: 6 • Bolt Circle: 6.75" • Bolt Size: 5/16" • Overall Depth: 3-11/16" • Inside Depth: 2-15/16" • Flange I.D.: 5-7/16" • Flange O.D.: 7-1/2" 	GT-4008	GT-4003	STEMCO 340-4195
	GT-4195G Dirt exclusion grease hub cap *Does not include gasket			GT-4000	STEMCO 342-4195
	GT-4195S Hub cap with side fill *Does not include gasket			GT-4003	STEMCO 343-4195
	GT-4195H Hubodometer hub cap with side fill *Does not include gasket			GT-4002	STEMCO 347-4195



Part Number		Size	Gasket	Window Kit	Replaces
	GT-4249S Hub Cap with side fill, 4-3/8" Window *Does not include gasket	<ul style="list-style-type: none"> • NO. Bolts 6 • Bolt Circle: 5.5" • Bolt Size: 5/16" • Overall Depth: 1-13/16" • Inside Depth: 1-11/16" • Flange I.D.: 4-7/16" • Flange O.D.: 6-3/16" 	GT-4006	GT-4912	STEMCO 343-4249
Part Number		Size	Gasket	Window Kit	Replaces
	GT-4095 Hub cap with out side fill *Does not include gasket	<ul style="list-style-type: none"> • NO. Bolts 6 • Bolt Circle: 5.5 • Bolt Size: 5/16 • Overall Depth: 1-13/16" • Inside Depth: 1-1/16" • Flange I.D.: 4-9/16" • Flange O.D.: 6-3/16" 	GT-4006	GT-4003	STEMCO 340-4095
GT-4095S	Hub cap with side fill *Does not include gasket				STEMCO 343-4095
Part Number		Size	Gasket	Window Kit	Replaces
	GT-4075 Hub cap with out side fill *Does not include gasket	<ul style="list-style-type: none"> • Bolt Circle: 6-1/4" x 8 UN (M) • Bolt Size: 5/16" • Overall Depth: 2-5/16" • Inside Depth: 1-9/16" • Flange I.D.: 5-3/4" • Flange O.D.: 6-7/8" 	GT-4021	GT-4003	STEMCO 340-4075
Part Number		Size	Gasket	Window Kit	Replaces
	GT-4640 Lexan hub cap	<ul style="list-style-type: none"> • NO. Bolts 6 • Bolt Circle: 5.5" • Bolt Size: 5/16" • Overall Depth: 2-11/16" • Inside Depth: 1-15/16" • Flange I.D.: 4-3/8" • Flange O.D.: 6-1/4" 	GT-4006	N/A	Sirco 9018
GT-4640	Lexan hubodometer hub cap				Stemco 640-0001 Sirco 9020
Part Number		Size	Bolt Circle Dia.		Replaces
	GT-4065 Hubodometer Bracket	Fits over all hubcaps ending in 4009 <ul style="list-style-type: none"> • Stud Size 5/16" - 18 Thread • Height 3 1/2" 	5-1/2"		Stemco 610-0065
Part Number		Size	Bolt Circle Dia.		Replaces
	GT-4084 Hubodometer Bracket	Fits PSI Hubcap and 4195 <ul style="list-style-type: none"> • Stud Size 5/16" • Height 5" 	6-3/4"		Stemco 610-0084



Pro Par Style Caps



Non Vented

GT-4020B	Specifications	Interchanges
Hub Cap For Fruehauf Propar Includes: Center plug O-Ring	Thread 6/1/4" Size 8 Material: Polycarbonate Replaces Fruehauf ACC-7538-900	Batco 11-0670 BWP M-1052 Euclid E-04075 Leland L-885 Meritor R004075 Sirco 9013 Spicer 8-295 Stemco 340-4975



Vented

GT-4020	Specifications	Interchanges
Hub Cap Vented For Fruehauf Propar Includes: Vented plug O-Ring	Thread 6/1/4" Size 8 Material: Polycarbonate Replaces Fruehauf ACC-7538-900	Euclid E-04075V



Hubodometer

GT-4020H	Specifications	Interchanges
Hub Cap Hubodometer Version For Fruehauf Propar Includes: Side fill plug O-Ring	Thread 6/1/4" Size 8 Material: Polycarbonate Replaces Fruehauf ACC-6113-900	Batco 11-0671 BWP M-2764 Euclid E-04075H Sirco 9015 Spicer 8-295H Stemco 640-0003

Wheel End



Window Kits



GT-4000



GT-4002

Part Number	Description	Replaces
GT-4003	3-1/2" window Dia.	Batco 11-0675 Stemco 359-5995
GT-4005	2-3/4" window Dia.	Stemco 359-5999
GT-4002	Hubo window for 4009 Series	359-6117
GT-4000	Grease cap window	359-6095
GT-4912	4-3/8" window Dia.	359-5912



Part Number	Description	Replaces
GT-4021	O-Ring Use with GT-4020 & GT-4075 6" O.D. 5-1/2" I.D.	Batco 11-0680 BWP M-1065 Euclid E-05500 Leland L-1700 Meritor Roo5500 Spicer 8-29F Stemco 330-3077

Plugs

↑
.70"
↓



GT-4001RED

Propar Style

↑
1"
↓



Part Number	Description	Replaces
GT-4001RED	GT-4001 Red Vented Plug	
GT-4001V	GT-4001V Black Vented Plug	359-5990
GT-4001NV	GT-4001NV Black Non-Vented Plug	
GT-4014V	GT-4014V Black Vented Plug	BWP M-1066
GT-4014NV	GT-4014NV Black Non-Vented Plug	Euclid E-04000 E-04000V Sirco B-9015 B-9015V



Gaskets

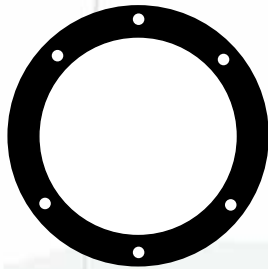

Part Number	Size	Replaces
GT-4025 Use with 4024 series Hub Caps	6 - Hole Small Gasket 4-1/2" B.C.	Batco 13-7156 BWP Euclid Leland Meritor Spicer Stemco 330-3024

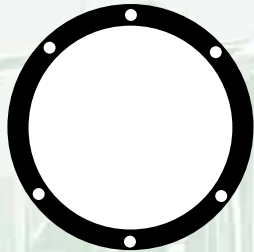

Part Number	Size	Replaces
GT-4006 Use with 4009, 4098, 4095 series Hub Caps	6 - Hole 6-13/16" O.D. 4-5/16" I.D. 5-1/2" B.C.	Batco 13-7151B BWP M-2768 Euclid Leland L-453 Meritor Spicer 8-304 Stemco 330-3009

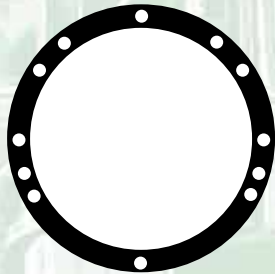

Part Number	Size	Replaces
GT-4004 Universal	12 - Hole 3, 5, 6, Hole 6-3/8" O.D. 4-7/16" I.D. 5-1/2" B.C.	Batco 13-7150B BWP M-837 Euclid E-03009 Leland Meritor Spicer Stemco 330-3067

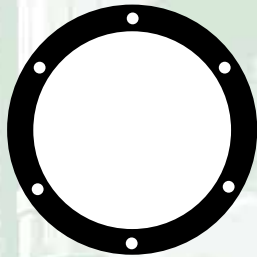

Part Number	Size	Replaces
GT-4008 TP Axle Gasket Use with 4195 Hubcap	6 - Hole 7-1/2" O.D. 5-7/16" I.D. 6-3/4" B.C.	Batco BWP Euclid Leland Meritor Stemco 330-3118 Wabaash 10600483

Description: GT-8011 is a low density cellulose fiber material with high rubber filler content and a nitrile butadiene rubber binder. It provides excellent sealing of oil and water at low flange pressures, and is used primarily for engine and transmission pan gaskets, water pumps, and environmental seals. It is intended for applications with short duration maximum temperatures up to 180°C (350°F). GT-8011 has UL component recognition.

Density, g/cc(lb/cu.ft)	0.61 (38) (min.)	ASTM F 1315
Compressibility, % (at 6.9MPa)	35 - 60	ASTM F 36
Recovery, %	15 (min.)	ASTM F 36
Tensile Strength, AMD, MPa (psi)	1.52 (220) (min.)	ASTM F 152
Fluid Resistance, IRM903 Oil		ASTM F 146
Change in Weight, %	120 (max.)	
Fluid Resistance, Fuel B		ASTM F 146
Change in weight, %	120 (max.)	
Fluid Resistance, Distilled Water		ASTM F 146
Change in Weight, %	45 (max.)	
Binder Type	Nitrile Butadiene	

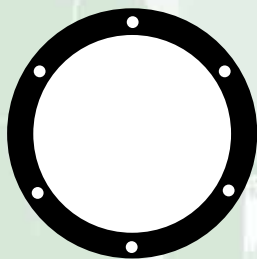



TEMPBOLT™ Patented

Avoid expensive bearing failures, unscheduled down time, costly road service calls and missed delivery appointments. Install the new **Globetech TempBolt™** in the hubcaps of your tractors and trailers today.

A **Globetech TempBolt™** installed in your hubcap can warn you of pending bearing problems. The TempBolt's visual red indicator pops out if the hub temperature reaches or exceeds 250° F. Only one **TempBolt™** is needed for each hubcap. This product is not a replacement for a rigorous hub preventive maintenance program.

- Tested and Approved by the TRUCK OEM Technical Center
- Several brake drag-tests were conducted to test drum temperature effect on the TempBolt™. The TempBolt™ did not activate due to high drum temperature. Only when the HUB exceeds 250° F does it activate.
- Anytime the oil temperature is consistently over 300° F, bearing failure can occur. At this temperature the oil will lose its lubricity causing the bearings to create more heat and eventually fail.
 - With the activation temperature set at 250° F, the **TempBolt™** warns you BEFORE a failure occurs.
 - In a typical operation, hub oil temperature runs between 150-200° F.
 - The **Globetech TempBolt™** can be used in any hub (tractor or trailer) that has a 5/16" diameter hubcap bolt.
 - When installing, do not exceed 14 ft. lbs. torque.

The **Globetech TempBolt™** is available in a "point-of-purchase" display box, containing 50 individual bags of 4 bolts. Encourage your customers to make it part of their preventative maintenance program.



GT-7600 BLK (Bulk)



GT-7600 (Single pkg.)



GT-7600B – (Tempbolt display Kit)
(incl. 50 pkg.)



Wheel Parts Inner/Outer Nuts



Inner Nut



Outer Nut

Part Number	Dayton Batco	BWP	Euclid	Sirco	Description	Plating	
I N N E R	GT-4E5988L	13-3026L	M-2401	E5988L	98AL	For dual mounted aluminum wheels Outer thread 1 1/8" - 16 Inner thread 3/4" - 16 inner thread min. depth 1 15/16" Outer overall length 3 1/16"	Zinc Clear
	GT-4E5988R	13-3026R	M-2400	E5988R	988AR		
	GT-4E7895L	13-3005L	M-129	E7895L	709AL	For dual mounted steel & aluminum wheels Outer thread 1 1/8" - 16 Inner thread 3/4" - 16 inner thread min. depth 1 1/4" Outer overall length 2 7/32"	All Zinc Yellow
	GT-4E7895R	13-3005R	M-128	E7895R	708AR		
	GT-4E7896L	13-3028L	M-131	E7896L	896L	For dual mounted steel & aluminum wheels Outer thread 1 1/8" - 16 Inner thread 3/4" - 16 inner thread min. depth 1 1/4" Outer overall length 2 9/16"	
	GT-4E7896R	13-3028R	M-130	E7896R	896R		
	GT-4E5568L	13-3029L	M-133	E5568L	897L	For dual mounted steel & aluminum wheels Outer thread 1 1/8" - 16 Inner thread 3/4" - 16 inner thread min. depth 1 7/8" Outer overall length 3 1/16"	
	GT-4E5568R	13-3029R	M-132	E5568R	897R		
O U T E R	GT-4E5977L	13-3012L	M-127	E5977L	892AL	Left and right outer nuts for all part numbers listed.	
	GT-4E5977R	13-3012R	M-126	E5977R	891AR		



Two Piece Metric Nut



GT-46000A

Description	THRD	HEX	High	Replaces
Metric 2-Piece Budd Unimount 10 Hub Piloted Wheels Teflon Coated	M 22 X 1.5	33 mm (1-19/64")	31 mm (1-7/32")	Euclid E-6000A Meritor R006000 Spicer 51-1033 Sirco 333B

Pro-Par Axle Nuts & Washers



GT-41226

GT-41226

Description:
Pro-Par Axle Outer Nut
Measurements:
4-3/4" x 3-1/2"-12 x
1-1/8" inches
Quality: grade 8
Material: SAE 1040/1050

REPLACES:
Martec: 1227D1226
Eaton: 4-2202
FRUACE8510-1
Trailmobile: 700-7-14



GT-43068

GT-43068

Description:
Pro-Par Axle Washer
Measurements:
3-1/2" I.D. 5-1/16" O.D.
x .255 thick

REPLACES:
Martec: 1229Z3068
Trailmobile: 700-7-15

Premium Aluminum Gaskets

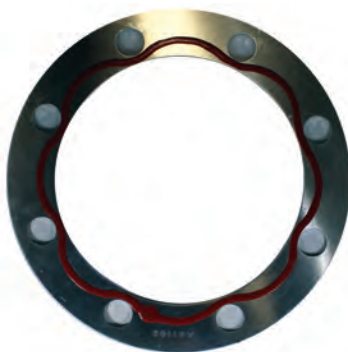

GT-4AG2106



GT-4AG2107



GT-4AG2111

Part Number	Holes	Description	Replaces Stemco
GT-4AG2106	8	Premium Aluminum Gasket 8 Hole 7" 5/8" Bolts 8-1/4" OD 6" ID	330-3106
GT-4AG2107	8	Premium Aluminum Gasket 8 Hole 7" 3/4" Bolts 8-1/2" OD 5-5/8" ID	330-3107
GT-4AG2111	8	Premium Aluminum Gasket 8 Hole 7" 5/8" Bolts 8-3/8" OD 5-3/4" ID	330-3111



PSI Hubcaps

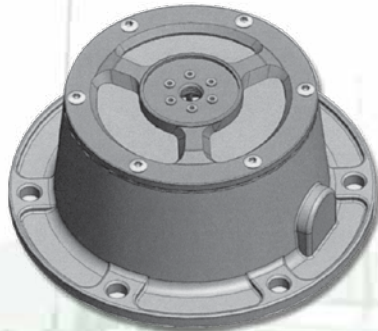

GT-4370

PSI, TN HUBCAP, GREASE, NO SIDE FILL, W/ NYLON WINDOW

Replaces Stemco: 340-4350 or 340-4370

Replaces Meritor: 31426-00

- Application: Grease
- Bolt Circle: 5.5
- Bolt Size: 5/16
- Overall Depth: 2-11/16
- Inside Depth: 1-15/16
- Flange Inner Diameter: 4-3/8
- Flange Outer Diameter: 6-1/4
- Replacement Window Kit: 359-6141

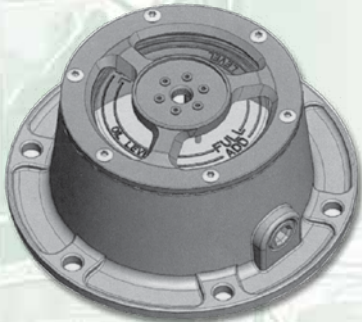

GT-4370S

PSI, TN HUBCAP, OIL, WITH SIDE FILL, W/NYLON WINDOW

Replaces Stemco: 343-4350 or 343-4370

Replaces Meritor: 31427-00

- Application: OIL
- Bolt Circle: 5.5
- Bolt Size: 5/16
- Overall Depth: 2-11/16
- Inside Depth: 1-15/16
- Flange Inner Diameter: 4-3/8
- Flange Outer Diameter: 6-1/4
- Replacement Window Kit: 359-6141

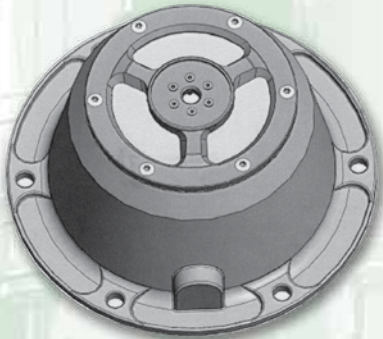

GT-4372

PSI, TP HUBCAP, GREASE, NO SIDE FILL, W/NYLON WINDOW

Replaces Stemco: 340-4352 or 340-4372

- Application: Grease
- Bolt Circle: 6.75
- Bolt Size: 5/16
- Overall Depth: 3-11/16
- Inside Depth: 2-15/16
- Flange Inner Diameter: 5-7/16
- Flange Outer Diameter: 7-1/2
- Replacement Window Kit: 359-6141

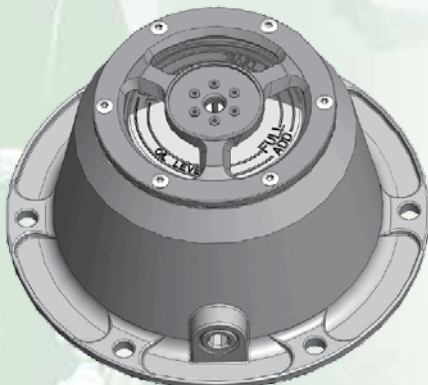

GT-4372S

PSI, TP HUBCAP, OIL, WITH SIDE FILL, W/NYLON WINDOW

Replaces Stemco: 343-4352 or 343-4372

- Application: OIL
- Bolt Circle: 6.75
- Bolt Size: 5/16
- Overall Depth: 3-11/16
- Inside Depth: 2-15/16
- Flange Inner Diameter: 5-7/16
- Flange Outer Diameter: 7-1/2
- Replacement Window Kit: 359-6141



Tire Inflation Hose



100% TESTED

GT-4120

Long Flex Hose
Replaces:
MTR31373-00

Standard Length 17.5" inches
*Also available in 19.5" inches

WORKS WITH ALL TIRE INFLATION SYSTEMS



GT-4121

Replaces:
MTR31363-00

Internal Check Valve

Protective Cover

Stainless Braided Line

NEW PART



GT-4123

Replaces:
810-0059

NEW PART



GT-4122

Replaces:
810-0060

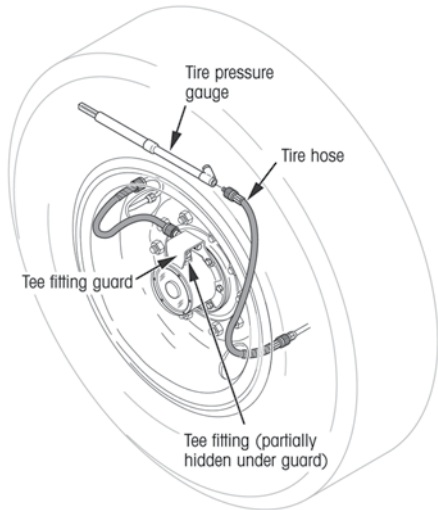

Tire Gage





**Inner Tube
GT-4300
(Blue Line)**



VALVE STEM: TR78A

Brass angled
STZF: 1000-20

Material: Butyl Blue line (High Tensile)
8-10 mpa

Packaged: Poly Bag 7 tubes per box

Part Number	Description
GT-4300	Standard 1000x20 8 MPA
GT-4302	Premium 1000x20 10 MPA
GT-4301	Tire flap liner

**Tire Repair Tool Kit
GT-4040**

- 1pc-Heavy-Duty steel T-handle Insert tool
- 1pc-Heavy-Duty steel T-handle spiral probe cement tool
- 2pc-replacement tool
- 60pc-4" string/plugs
- 1pc-lubricating oil



Wheel End



Tire Inflator Kit

- 1/4" straight air hose for air tool (or other low pressure pneumatic applications)
- Self-storing, 50 foot length
- 2 x 1/4" NPTF male swivel fittings with spring guards are included
- 300 psi is maximum recommended operating pressure at 78°F
- OSHA (STD1-13-001) compliant when used with safety tip only

Inflator Kit Includes Coil Assembly and:

- 1/2" x 1/4" Bushing
- Male End Connector
- Female Disconnect
- Universal Gladhand (Part No. 5330)
- Air Chuck (Part No. 451060)
- Blow Gun w/male disconnect (Part No. 451065)



GT-451070



GT-14210

Fifth Wheel Slider Coil

Part Number	Description	Replaces Tectran
GTA-14210	Fifth Wheel Slider Coil	14210

Blow Gun



GT-451065

Part Number	Description	Replaces Tectran
GT-451065	Blow gun w/male disconnect, 1/4" NPT	A148

Tire Chucks/Tire Gauges



GT-45130



GT-45135

Part Number	Description	Replaces Tectran
GT-45130	6" dual foot air chuck. 1/4" NPT	A824
GT-45135	Dual foot tire gauge, nylon bar, 10-150 psi	6A135



Valve Stems - USE: Steel Wheels



Part Number	Length	Replaces
GT-TR501	1-1/2"	Haltec TV-501
GT-TR572	3-3/4"	Haltec TV-572
GT-TR573	4-3/8"	Haltec TV-573

Valve Stems - USE: Aluminum Wheels



Part Number	Length	Bend Angle	Replaces
GT-TR544D	2"	60°	Haltec TV-544D
GT-TR545D	2/5/8"	60°	Haltec TV-545D
GT-TR509	4-3/4"	90°	Haltec TV-509
GT-TR510	5-1/2"	90°	Haltec TV-510



Valve Stems - USE: Steel Wheels



Part Number	Description	Replaces
GT-TE382	5-1/16" valve extension with 1" collar	Haltec 382



Valve Stem Accessories



GT-DS-1

Metal Double Seal Cap

This double seal cap seals at the top of the cap which prevents dirt and water from penetrating the cap, eliminating the chances of clogged air passages due to ice and debris. Allows for inflation and deflation of the tire without removing the cap. A great time saver.

Replaces Haltec DS-1

Valve Caps (Standard Bore)



GT-VC-3



GT-VC-8



GT-VC-1

Part Number	Description	Replaces
GT-VC-3	Nickel-plated	Haltec A 100-VC-3
GT-VC-8	Black plastic	Haltec A-100-VC-8

Valve Core

Part Number	Description	Replaces
GT-VC-1	Standard bore heat resistant core for cars, trucks and buses	Haltec A 100-VC-1

Standard Bore 4-way valve Tool



Part Number	Description	Replaces
GT-TL610	Repairs and conditions inside and outside valve threads. Inserts and removes cores. Corrosion-resistant, cadmium-plated	Haltec A 100-VC-1



Freeze Plugs GT-6200

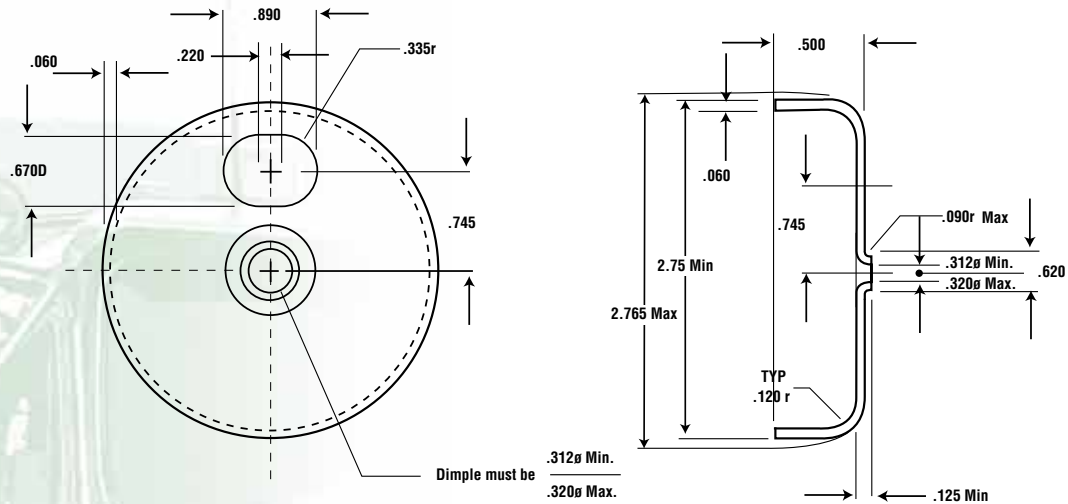

Part Number	Description	Replaces
GT-6200	Freeze plug	Wabash 10600526

Freeze Plugs GT-6202

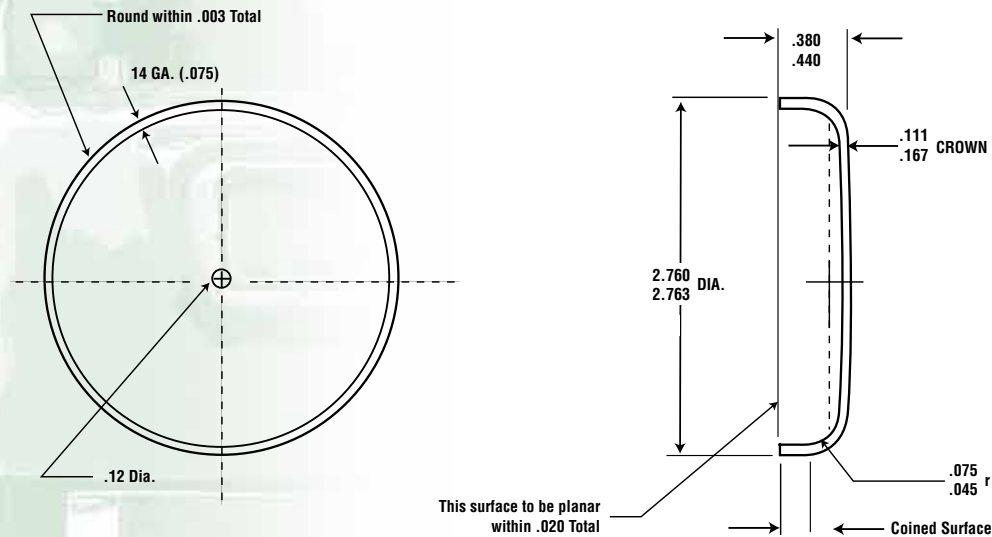

Part Number	Description	Replaces
GT-6202	Freeze plug	Haldex 102434T Fruehauf A-CD7180-1

ABS GEN2

Trailer Anti-Lock
Braking System

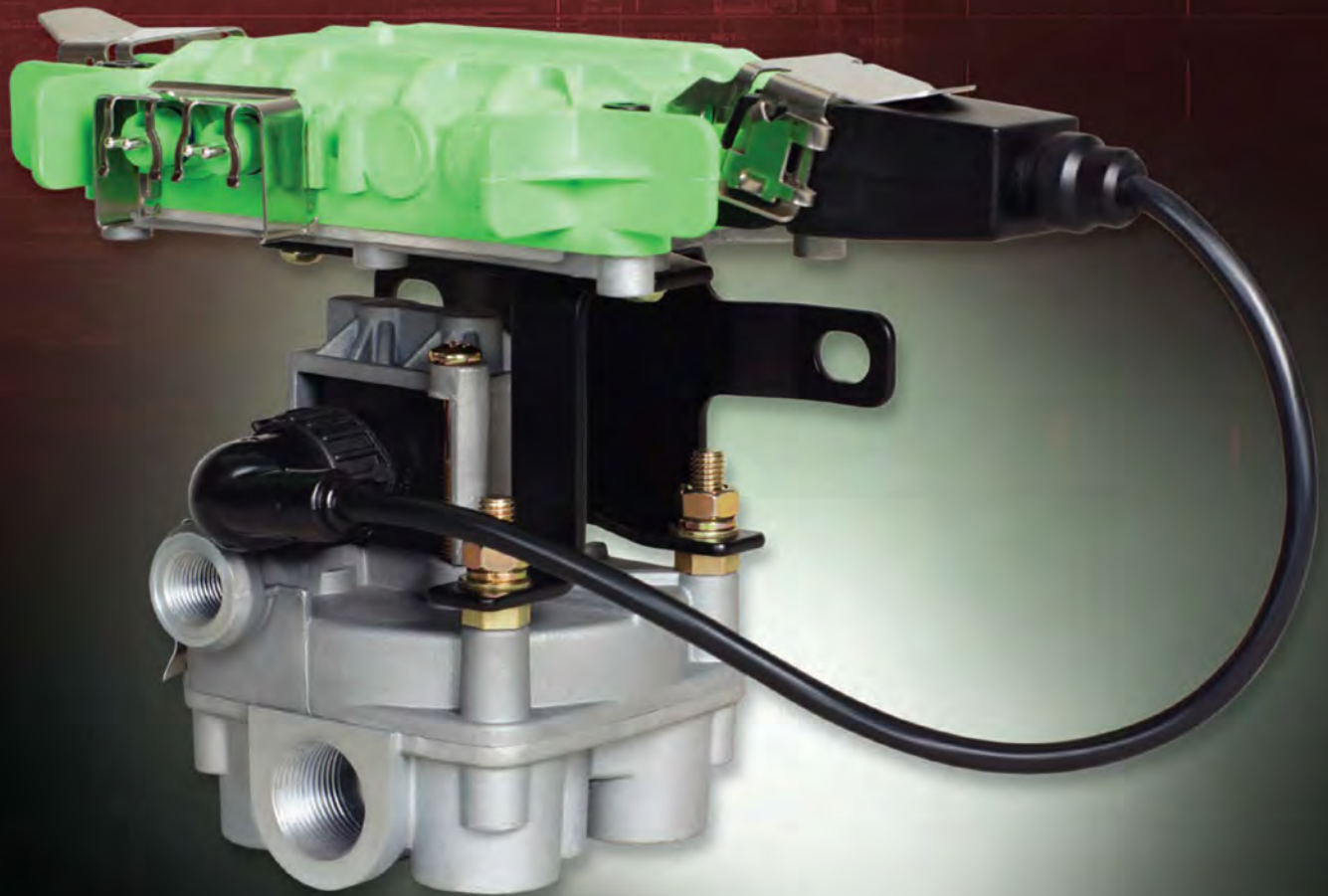

Smart ECU. Smart Investment.

Trailer monitoring and control is critical for any fleet or vehicle operator on the road today. From safe stopping to rollover prevention to cargo protection and more, the trailer anti-lock braking system (ABS) plays a key role in productivity and uptime. For maximum time on the road, you need a cost-effective ABS solution that's easy to install and maintain while taking advantage of the latest in communications technology.

Introducing Gen2 Trailer ABS. Gen2 allows you to quickly and easily replace your existing trailer ABS

electronic control unit (ECU) for unparalleled trailer monitoring and control with more capabilities. Standard ABS ECUs utilize external tools and software for system diagnostics. Gen2 is a SMART ECU that does not require the use of external software for diagnostics and fault codes. By integrating exclusive control logic into the ABS governing hub and information portal, Gen2 allows for highly efficient diagnostic evaluation and dramatically lower cost of operation.

www.gen2abs.com

GEN2 ABS 4S/1M

- Connection to all four ports of valve
 - 2 for front axle
 - 2 for rear axle

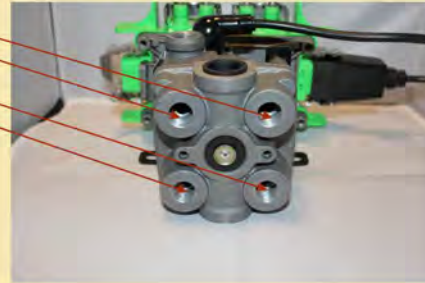
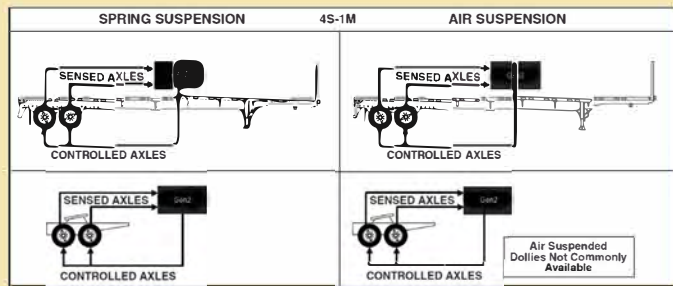

- FASTEST GEN2 SYSTEM
- COST LESS
- SENSES ALL FOUR WHEEL ENDS
- ELIMINATES FLAT SPOTS
- EASIEST DROP IN REPLACEMENT
- TANK MOUNT INSTALLATION

- WEIGHS 3 LBS. LESS
- WIFI DIAGNOSTICS
- OUT PERFORMS WABCO'S ABS CYCLE
- REDUCE INVENTORY
- ONLY ONE VALVE USED FOR 4S OR 2S SYSTEM



WABCO 4S/2M



GEN2 ABS 4S/1M

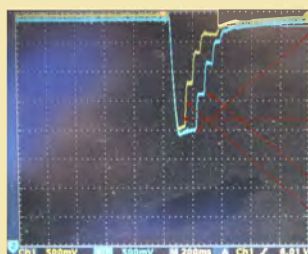

- Exhaust is half of the total exhaust. This equates to release of the tire
- Short width equates to quick stutter of tire brake actuation
- Few cycles on build up
- One side is dominant showing an imbalance

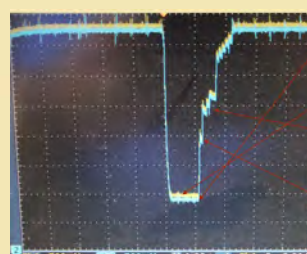

- Exhaust has capability to almost completely release tire
- Burst has greater flexibility to control tire
- Pressure build up more robust to provide greater control
- Symmetry on both side provides balance to trailer

WABCO 4S/2M ABS CYCLE VS. GEN2 4S/1M

The First to Offer Intelligent Interface.

Gen2 offers revolutionary communication capabilities. It is the first trailer ABS to incorporate a WiFi access point that sends diagnostics to any smartphone or tablet. Now you can receive mobile alerts including the most complete diagnostic information without the need for additional software or diagnostic tools. Future plans for Gen2's intelligent interface include additional monitoring capabilities such as brake and pad wear, tire inflation, trailer tracking and more. All to enhance your condition-based trailer maintenance programs.

Take advantage of the industry-first Gen2 intelligent interface and be at the forefront of innovative trailer ABS diagnostic communications.

System Requirements.

Gen2 provides reliable performance day in and day out. Whether you need a 2S/1M single-channel system or a 4S/2M multi-channel system, we offer the right configuration to meet your trailer needs.

2S/1M Basic

A 2-sensor/1-modulator system offers increased assistance to the driver in maintaining directional stability and control while meeting FMVSS 121 requirements.



ECU Only - WiFi & PLC GEN2-2010

Includes: WiFi & PLC
Will interchange with Meritor ECU to upgrade existing system



Gen2 Advantages.

- ECU can be used on existing Meritor WABCO® ABS platforms
- First to offer WiFi interface
- Does not require costly software and tools to maintain
- Diagnostics can be performed from a smartphone or tablet
- No blink code diagnostics needed
- Approved by major OEM trailer manufacturers

Exceptional Support, Mile After Mile.

The Gen2 ECU is covered by a 3-year warranty. All other Gen2 system parts are covered by 1-year standard aftermarket warranty.

2S/1M Kit with PLC GEN2-1010

Includes:

- ECU: GEN2-2010
- Valve: GEN2-0330
- Modulator Cable: GEN2-2752
- Bracket: GEN2-0584

GEN2-0210

Replaces: R955344 & S472 500 021 0

Includes:

- ECU: GEN2-2010
- Valve: GEN2-0330
- Modulator Cable: GEN2-2752
- Bracket: GEN2-0584
- Power Cable: GEN2-3130

GEN2-1010

***All parts interchangeable
with Meritor for upgrading**



GEN2-1031

4S/1M Kit with PLC & WiFi
Replaces S4005001030

includes:
ECU: GEN2-6011
Valve: GEN2-0330

Part Number	Description	Interchange
ABS Components		
		Replaces Meritor®
ECU ONLY		
GEN2-2010 *	2S/1M ECU Only (WIFI)	S4008506000/S4461082060
GEN2-6011	4S/1M ECU Only (WIFI)	S4008506010
GEN2-6010	4S/2M ECU Only (WIFI)	S4008506010
FULL ECU/VALVE COMBO/UNIT		
GEN2-1010	2S/1M Valve/ECU (WIFI, No Power Cable)	S4005001010
GEN2-1031 *	4S/1M Valve/ECU (WIFI)	S4005001030
GEN2-1030	4S/2M Valve/ECU (WIFI)	S4005001030
GEN2-0210	2S/1M Kit (Includes GEN2-3120 Cable)	R955344/S4725000210
GEN2-0233	2S/1M Kit Includes GEN2-0100 Power Cable	
	2s/1m Complete Retrofit Kit, Includes GEN2-1010, GEN2-0470, 2 ea GEN2-0180, 2 ea GEN2-5349	R955374
GEN2-5374		R955374
GEN2-K21220	2S/1M Kit Includes GEN2-0100 and GEN2-0300	Replaces Sealco 21220
BRACKETS		
GEN2-0584	Bracket for 2S/1M	S4784070584
GEN2-0585	Bracket for 4S/2M	
MODULATOR CABLES		
GEN2-2752	Modulator Cable 2S/1M	S894662752
GEN2-2753	Y Modulator Cable for 4S/2M	
VALVES		
GEN2-0330	Valve GEN2-1010/1030/1031	S4721950330/S4008506020
ACCESSORY CABLES		
GEN2-0470	14ft 4 Conductor Power Cable	S4493260470
GEN2-3120	1ft Power Adapter Cable	S8946073120
GEN2-0100	3.3 ft Power Power Cable	S4493260100
GEN2-0101	7.5 Power Cable	
MISC. ACCESSORIES		
GEN2-8154	ABS Sensor Clip	R955458
Meritor WABCO® Style ABS Sensors		
		Replaces Meritor
GEN2-5349	2 ft Straight	
GEN2-5329	5.6 ft Straight	R955329
GEN2-5337	5.8 ft Straight	R955337
GEN2-5335 *	1 ft 90 degree	R955335
GEN2-5336	3 ft 90 degree	R955336
GEN2-5365	4.6 ft 90 degree	R955365
GEN2-5341	5.8 ft 90 degree	R955341
GEN2-5342	6.6 ft 90 degree	R955342
Bendix® Style ABS Sensors		
		Replaces Bendix
GEN2-801544	1 ft 90 degree; GDA5801544	801544
GEN2-801545	8.6 ft 90 degree; GDA80145	801545
GEN2-801546	5 ft 90 degree; GDA801545	801546
ABS Extension Cables		
		Replaces Haldex®/Meritor
GEN2-AL919802	4.9' ABS Extension Cable	AL919802
GEN2-AL919803	6.6' ABS Extension Cable	AL919803
GEN2-AL919806	11.5' ABS Extension Cable	AL919806
GEN2-0180 *	6' ABS Extension Cable	S4497130180
GEN2-0300	10 ft ABS Extension Cable	S4497130300
* (most popular used for OEM builds)		

ABS Sensor Extension Cables

Part Number	Description	Replaces Haldex
GEN2-AL919802	ABS Sensor Extension Cable 4.9' Ft.	AL919802
GEN2-AL919803	ABS Sensor Extension Cable 6.6' Ft.	AL919803
GEN2-AL919806	ABS Sensor Extension Cable 11.5' Ft.	AL919806
GEN2-0180	ABS Sensor Extension Cable 5.8' Ft.	S4497130180
GEN2-0300	ABS Sensor Extension Cable 10' Ft.	S4497130300



ABS Sensor Kits

Part Number	Description	Harness Length	Replaces
GEN2-5329	Straight	5.6 ft.	R955329
GEN2-5337	Straight	5.8 ft.	R955337
GEN2-5335	90 degree	1 ft.	R955335
GEN2-5336	90 degree	3 ft.	R955336
GEN2-5365	90 degree	4.6 ft.	R955365
GEN2-5341	90 degree	5.8 ft.	R955341
GEN2-5342	90 degree	6.6 ft.	R955342



includes spring clip
GTA-8997598154
& grease tube

ABS Sensors

Part Number	Description	Connector Type	Harness Length	Replaces Bendix
GEN2-801544	90 degree	DIN	1 ft.	801544
GEN2-801545	90 degree	Deutsch	8.6 ft.	801545
GEN2-801546	90 degree	Deutsch	5 ft.	801546



Power Cable

GEN2-0470

Easy stop 4 conductor pigtail power cable.

Replaces: S4493260470



Power Adapter Cable

GEN2-3120

Power adapter cable.

Replaces: S8946073120



Modulator Cable Relay

GEN2-2752

Easy stop 4 conductor pigtail power cable.

Replaces: S8946062752



“Y” Modulator Cable

GEN2-2753

“Y” 4S/2M Modulator Cable

Used on Globetech GEN2-1030 4S/2M system



Sensor Clip

GEN2-8154

Sensor clip

Replaces: S8997598154





Spring Brakes

Globetech's Spring Brakes are Assembled in the U.S.A.

- Combination of USA made components and imported components
- Each chamber is assembled in the USA and date coded
- Each component is inspected before assembly



Globetech's Spring Brakes are 100% Tested in the U.S.A.

- Meets all SAE J14659 Air Actuators test procedures
- Cycle life test passed for 1 million cycles on parts side and over 200K on spring side

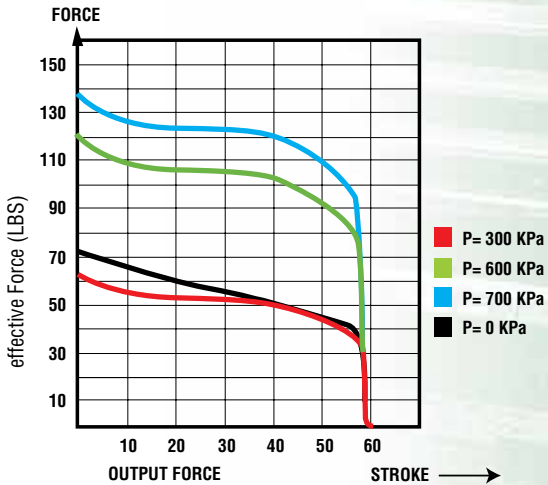



Spring Brakes

Renaissance

SERIES

Technical Information

4 YEAR WARRANTY

Power Spring

Black passivated and passes 48 hr salt spray test
CNC coiled and meets both force and life cycle requirements as published by Society of Automotive Engineers 1 million cycle test

Non-Pressure Housing

11 Gauge with reinforced mounting bolts to prevent damage
Black E-coating and passes 200 hr salt spray test

Clamp Bands

Matched stamping for maximum seal and life
High strength steel material consistent long-life pressure
Zinc coated and corrosion prevention passes 72 hr salt spray test

Push Rod

Thick steel plate exceeds all OEM standards
Rolled edge creates smooth working surface
Orange stroke alert indicator OEM
CNC welding for push rod/plate attachment (very strong)

Aluminum Adapter

Die cast 360 spec. aluminum
Double O-Ring seal
Ground/plated push rod for smoothest friction surface

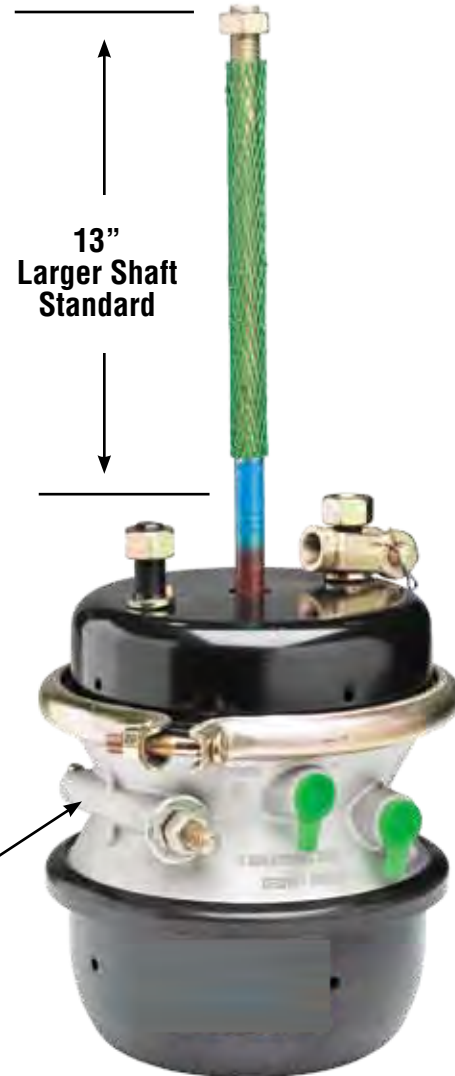

Date Code

Diaphragm

Natural/synthetic rubber blend
Meets SAE 1 million cycle test

Return Springs

.177 Spring wire SAE tested to 1 million cycles

Fasteners

All Fasteners are tensile strength and adhere to SAE standards





Brake Chambers



Part Number	Description	OEM	Replaces Ranger
GTA-BC2024	Type 2024 OEM sealed spring brake (Renaissance)		BTS-2024
GTA-BC2424	Type 2424 OEM sealed spring brake (Renaissance)		BTS-2424
GTA-BC2424LS	Type 2424 OEM sealed long sroke spring brake (Renaissance)		BTS-2424LS
GTA-BC2430	Type 2430 OEM sealed spring brake (Renaissance)		BTS-2430
GTA-BC2430LS	Type 2430 OEM sealed long stroke spring brake (Renaissance)		BTS-2430LS
GTA-BC3030	Type 3030 OEM sealed spring brake (Renaissance) USA MADE		BTS-3030
GTA-BC3030LS	Type 3030 OEM sealed long stroke spring brake (Renaissance)		BTS-3030LS
GTA-BC3036	Type 3036 OEM sealed spring brake (Renaissance)		BTS-3036
GTA-BC3636	Type 3636 OEM sealed spring Brake (Renaissance)		BTS-3636
GTA-BC3030-4.5DB	3030 sealed w/ 4.5 rod/dust boot/clevis (Mack)		BTS-3030-4.5 BC
GTA-3030-WCR	Type 3030 welded clevis replacement		3030-WCR
GTA-3030LS-WCR	Type 3030 longstroke welded clevis replacement		3030LS-WCR

Value Chamber 100% Tested



Part Number	Description	Aftermarket Series	Replaces Ranger
GTA-BC3030V	Type 3030 valve chamber gold zinc 14" shaft (Economy)		n/a

Piggybacks



Part Number	Description	OEM	Replaces Ranger
GTA-BC3030P	Type 3030 piggyback		BPS-3030
GTA-BC3030PK	Type 3030 piggyback kit w/ 1 diaphragm, 2 clamps, and installation hardware		BPS-3030K
GTA-BC3030PLSK	Type 3030 piggyback long stroke kit		BPS-3030KLS
GTA-BC2024P	Type 2024 Piggyback		BPS-2024
GTA-BC3036P	Type 3036 Piggyback		BPS-3036

Service Chambers



Part Number	Description	OEM	Replaces Ranger
GTA-BC36	Type 36 service chamber		BSC-36
GTA-BC30LS	Type 30 service chamber long stroke		BSC-30LS
GTA-BC30SC-WCR	Type 30 service chamber (welded clevis assembly)		30SC-WCR
GTA-BC30	Type 30 service chamber		BSC-30
GTA-BC24	Type 24 service chamber		BSC-24
GTA-BC20	Type 20 service chamber		BSC-20
GTA-BC16	Type 16 service chamber		BSC-16
GTA-BC12	Type 12 service chamber		BSC-12
GTA-BC09	Type 9 service chamber		BSC-09



Air Brakes



Part Number	Description	Replaces Ranger
GTA-30DB	Dust boot	RB-30DB
GTA-006	Type 30 return spring	RB006
GTA-30PS	Type 30 power spring	RB30PS
GTA-009	Carriage bolt&nut 3/8"-16 (Attaches clamps to chamber)	RB009
GTA-010	Jam nut 5/8"-18 (Attaches end of push rod for clevis mount)	RB010
GTA-30DC	Dust caps (Black cap that attaches to bottom of chamber)	RB-30DC
GTA-008	T-Bolt Assembly set (1-Washer, T-bolt, T-bolt nut)	RB008
GTA-9PR	T-9 push rod	RB-9PR
GTA-12PR	T-12 push rod	RB-12PR
GTA-16PR	T-16 push rod	RB-16PR
GTA-20PR	T-20 push rod	RB-20PR
GTA-24PR	T-24 push rod	RB033
GTA-30PR	T-30 push rod	RB034
GTA-36PR	T-36 push rod	RB-36PR
GTA-9NPH	T-09 non pressure "stud" housing	RB-9NPH
GTA-12NPH	T-12 non pressure "stud" housing	RB-12NPH
GTA-16NPH	T-16 non pressure "stud" housing	RB-16NPH
GTA-20NPH	T-20 non pressure "stud" housing	RB-20NPH
GTA-24NPH	T-24 non pressure "stud" housing	RB-24NPH
GTA-30NPH	T-30 non pressure "stud" housing	RB020
GTA-36NPH	T-36 non pressure "stud" housing	RB-36NPH



Diaphragms Clamps, Clevis Assemblies



- Heavy Duty
- Reinforced molded sides meets OEM standards
- Style: clamp ring
- Other styles available by special order

Part Number	Type	Description	Replaces Midland#	Replaces Bendix#	Replaces Ranger
GT-5205	9	Air Brake Diaphragm 5"	KN18090	234433	RB-D-9
GT-5206	16	Air Brake Diaphragm 6"	KN18160	234189	RB-D-16
GT-5208	24	Air Brake Diaphragm 7"	KN18240	234100	RB-D-24
GT-5209	30	Air Brake Diaphragm 8"	KN18300	234101	RB-D-30
GT-5210	30	Air Brake Diaphragm 7-27/32" Long Stroke			RB-D-303
GT-5211	12	Air Brake Diaphragm 5-1/2"	KN18120	234226	RB-D-12
GT-5212	20	Air Brake Diaphragm 6-1/2"	KN18200	234099	RB-D-20
GT-5213	24	Air Brake Diaphragm Long Stroke			RB-D-243
GT-5214	36	Air Brake Diaphragm		234362	RB-D-36

Chamber Clamps



- Black powder coat
- Individual poly bagged
- Type 30 (GT-5280)

Wider for easier piggy backs and chamber repairs!



Part Number	Type	Description	Replaces Ranger
GTA-5280	30	Steel Chamber Clamp Kit (carriage bolts, nuts, clamps)	RB053
GTA-5281	9	Steel Chamber Clamp Kit (carriage bolts, nuts, clamps)	RB9CK
GTA-5282	12	Steel Chamber Clamp Kit (carriage bolts, nuts, clamps)	RB12CK
GTA-5283	16	Steel Chamber Clamp Kit (carriage bolts, nuts, clamps)	RB16CK
GTA-5284	20	Steel Chamber Clamp Kit (carriage bolts, nuts, clamps)	RB20CK
GTA-5285	24	Steel Chamber Clamp Kit (carriage bolts, nuts, clamps)	RB016
GTA-5286	36	Steel Chamber Clamp Kit (carriage bolts, nuts, clamps)	RB36CK



Air Coils



AIR-COILS
FIRE & ICE

Withstands temperatures from 212°F (100°C) to -40°

- Coiled, 1/2" O.D. reinforced nylon tubing
- Excellent coil memory and durability
- Color-coded (red - emergency / blue - service) Meets SAE J844 and DOT FMVSS 106 - (49 CFR 571.106 & 49CFR 393.45)
- Designed for 150 psi operating systems
- Resistant to attack by gasoline, diesel fuel, methyl-alcohol and zinc chloride
- Male pipe - brass fittings
- Heavy duty plated spring guards
- D.O.T. fittings



Standard Air Coils DOT FMVSS 106

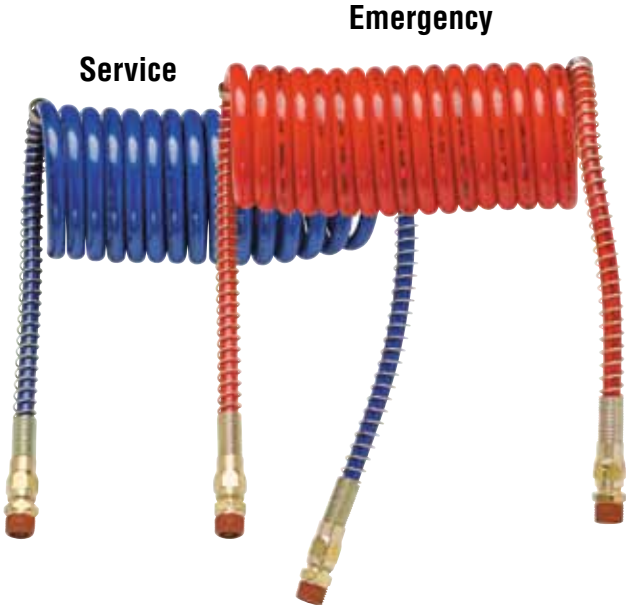

Globetech's Air Coils have excellent coil memory

Manufacturer Marking

Hose Type

SAE Tested

Hose Size

D.O.T. Approved

Date Code



Heavy Duty Air Coils

Part No.	Description	Replaces Tectran	Replaces Phillips
GTA-120606	12" 2 x 06" lead	17212	11-312
GTA-151212	15" 2 x 12" lead	17215	11-315
GTA-151213	15" 1 - 12" lead 1 - 40" lead		11-340
GTA-151214	15" 1 - 12" lead 1 - 48" lead	17215-040	
GTA-201212	20" 2 x 12" lead	17220	11-320

all references to competitors' part numbers are for cross reference purposes only



Xtreme Cold Weather Air Coils GT-151212, GT-151213, GT-151214 Meets DOT FMVSS 106



- Large, 5" coil diameter to improve flexibility
- Pre-applied thread sealant provides air tight seal
- Jacketing provides superior recoil memory. Chemical and abrasion resistance
- Remains flexible to **-85°F** for extreme cold weather protection
- Brass POWER GRIP long brass handle for easy coupling/uncoupling

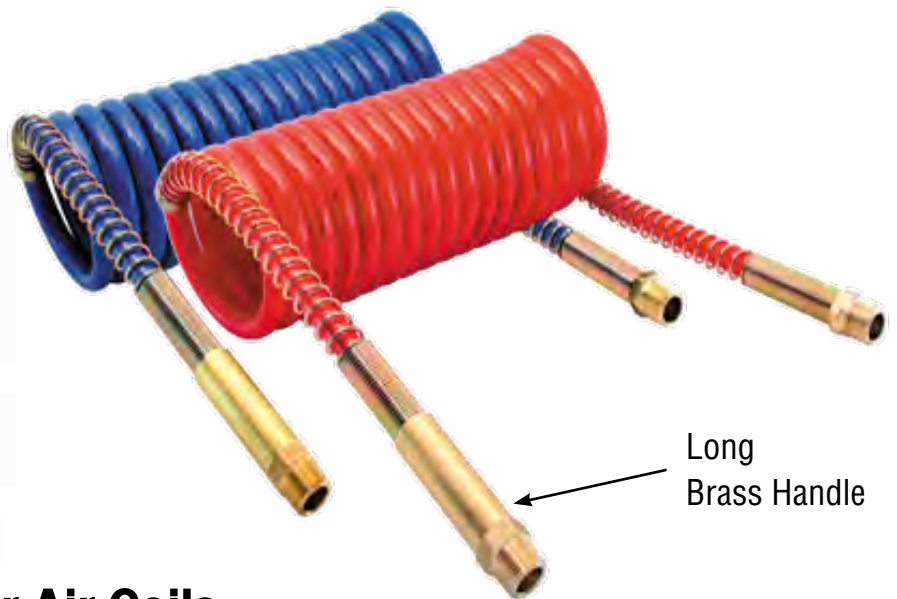

Xtreme Cold Weather Air Coils

Part No.	Description	Replaces Tectran	Replaces Phillips
GTA-120606X	12" 2 x 06" lead	17B12H	11-5120
GTA-151212X	15" 2 x 12" lead	17B15H	11-5150
GTA-151213X	15" 1 - 12" lead	17B15-40H	11-5400
	1 - 40" lead		
GTA-151214X	15" 1 - 12" lead	17A15-40H	
	1 - 48" lead		
GTA-201212X	20" 2 x 12" lead	17B20H	11-5200



3 Layer Xtreme Weather Air Coils

- Nylon inner layer reinforced with nylon webbing (1)
- Nylon inner layer (2)
- Urethane outer layer (3)

Air Brakes



Air-Electric 3 to 1 Combo GT-3320

GT-3007 - 7 way OEM Plug
GT-3320 - 15 Ft. 3 to 1 Combo
GT-3321 - 12 Ft. 3 to 1 Combo
GT-3322 - 20 Ft. 3 to 1 Combo
GT-3600 - 15 Ft. Spiral Wrap
GT-5341 - Red/Blue Aluminum Hex Grips

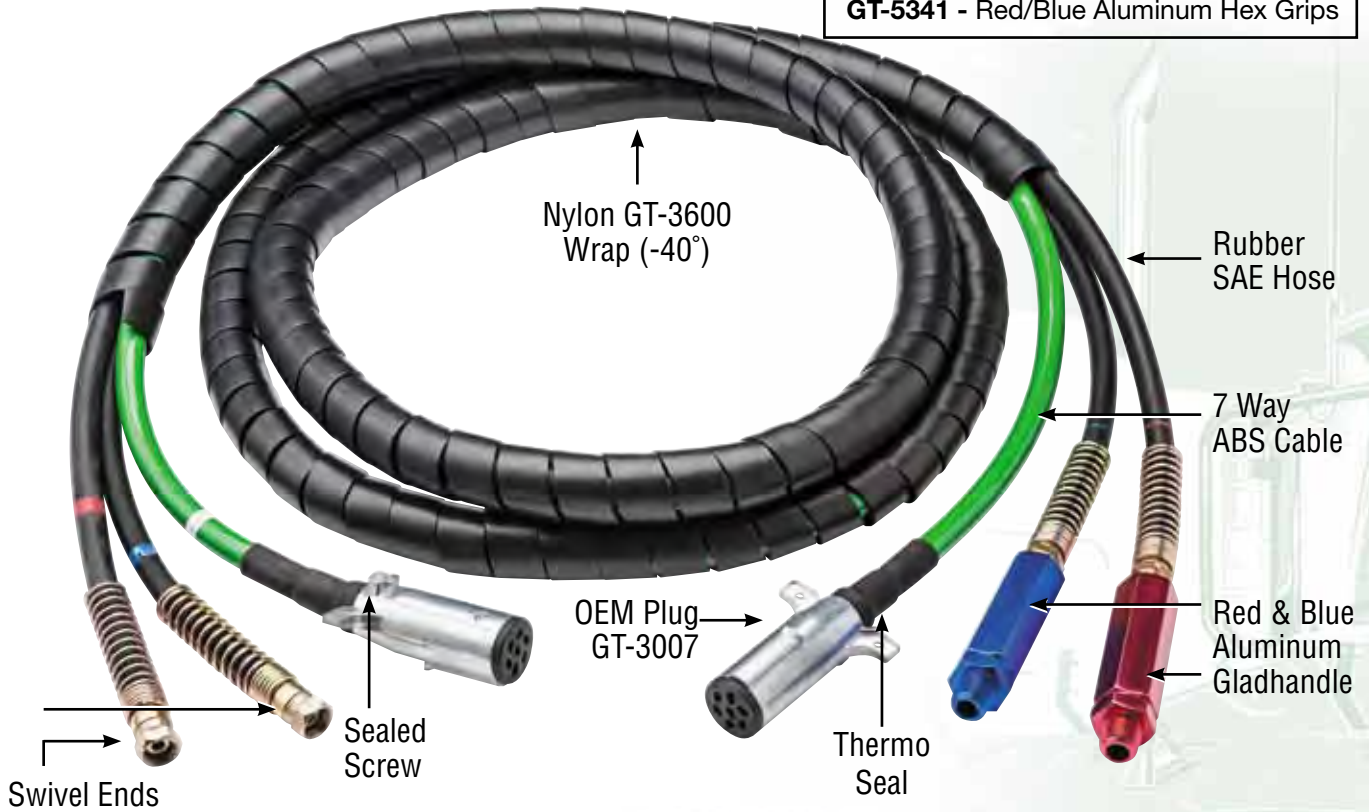

GT-3600 - Spiral Wrap

- 15/ft. long
- Make your own air power assemblies
- Flexible nylon material flexible to -40° F
- U.V. resistant

Replaces
TECTRAN - 832SPR



Gladhand & Plug Holder
GT-5391



Air Line Hanger Clamp
GT-5379



Gladhand & Plug Holder
GT-5392



Large Carabiner
GT-5376



Rubber Air Brake Hose (Bulk)

Manufactured to OEM Specs



Destructive Tests

Destructive tests are conducted on short specimens of hose, normally 18 inches to 36 inches in length and, as the name implies, the hose is destroyed in the performance of the test.

- A. Burst pressure is recorded as the pressure at which actual rupture of a hose occurs.
- B. A hold test, when required, is a means of determining whether weakness will develop under a given pressure for a specified period of time.

Non-Destructive Tests

- a. Proof pressure test
- b. Change in length test (elongation or contraction)
- c. Change in outside diameter or circumference test
- d. Warp test
- e. Rise test
- f. Twist test
- g. Kink test
- h. Volumetric expansion test

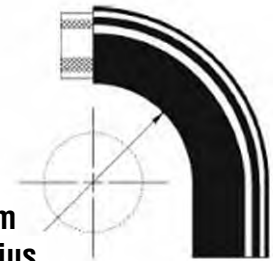

Minimum Bend Radius

Minimum Hose Bend Radius Data (MBR)

The Bend Radius is the radius of the bent section of a hose measure to the innermost surface of the curved portion. It is important because the minimum bend radius is the maximum amount a hose can be bent without being kinked or damaged.

AIR BRAKE, TYPE A - SAE J1402 & DOT FMVSS 106

Air Brake hose is designed for conveying air in truck and trailer brake systems. Truck and trailer manufacturers, aftermarket packagers and wholesalers use this hose. It is certified to meet D.O.T. FMVSS 106 and SAE J1402A requirements. The EPDM tube and cover with the 4-spiral reinforcement make this hose virtually kink proof. This hose is durable enough to handle this safety related application.



Cover Color:	Black
Oil Resistance:	Medium
Construction:	
Tube:	EPDM, RMA Class C
Cover:	EPDM, RMA Class C
Reinforcement:	Spiral polyester yarn
Temperature Range:	-40°F to +200°F -40°C to +93°C
Packaging:	† Maximum 2 pc. 250 ft. reel, **50 ft. length – 1 per carton

Part No.	Nominal I.D. (in)	Nominal O.D. (in)	Working Pressure	Min. Bend Radius (in)	Weight (lb/ft)	Length
GTA-38000	3/8	.75	Min. Burst 900	2.25	0.17	250 ft
GTA-12000	1/2	.88	Min. Burst 900	3.00	0.20	250 ft



Air Brake Hose Assemblies

- Factory tested to ensure quality
- Meets or exceeds SAE J1402 – Type A
- Meets or exceeds DOT FMVSS No. 106 – Brake Hoses, 49 CFR 571.106
- Available from stock in a wide selection of lengths and end configurations



3/8" Hose, 3/8" Ends			1/2 Hose, 3/8" Ends	
Length	Fixed/Swivel	Swivel/Swivel	Fixed/Swivel	Swivel/Swivel
8	GTA-3838F08	GTA-3838S08	GTA-1238F08	GTA-1238S08
12	GTA-3838F12	GTA-3838S12	GTA-1238F12	GTA-1238S12
14	GTA-3838F14	GTA-3838S14	GTA-1238F14	GTA-1238S14
16	GTA-3838F16	GTA-3838S16	GTA-1238F16	GTA-1238S16
18	GTA-3838F18	GTA-3838S18	GTA-1238F18	GTA-1238S18
20	GTA-3838F20	GTA-3838S20	GTA-1238F20	GTA-1238S20
22	GTA-3838F22	GTA-3838S22	GTA-1238F22	GTA-1238S22
24	GTA-3838F24	GTA-3838S24	GTA-1238F24	GTA-1238S24
26	GTA-3838F26	GTA-3838S26	GTA-1238F26	GTA-1238S26
28	GTA-3838F28	GTA-3838S28	GTA-1238F28	GTA-1238S28
30	GTA-3838F30	GTA-3838S30	GTA-1238F30	GTA-1238S30
32	GTA-3838F32	GTA-3838S32	GTA-1238F32	GTA-1238S32
34	GTA-3838F34	GTA-3838S34	GTA-1238F34	GTA-1238S34
36	GTA-3838F36	GTA-3838S36	GTA-1238F36	GTA-1238S36
38	GTA-3838F38	GTA-3838S38	GTA-1238F38	GTA-1238S38
40	GTA-3838F40	GTA-3838S40	GTA-1238F40	GTA-1238S40
42	GTA-3838F42	GTA-3838S42	GTA-1238F42	GTA-1238S42
44	GTA-3838F44	GTA-3838S44	GTA-1238F44	GTA-1238S44
46	GTA-3838F46	GTA-3838S46	GTA-1238F46	GTA-1238S46
48	GTA-3838F48	GTA-3838S48	GTA-1238F48	GTA-1238S48
50	GTA-3838F50	GTA-3838S50	GTA-1238F50	GTA-1238S50
52	GTA-3838F52	GTA-3838S52	GTA-1238F52	GTA-1238S52
54	GTA-3838F54	GTA-3838S54	GTA-1238F54	GTA-1238S54
56	GTA-3838F56	GTA-3838S56	GTA-1238F56	GTA-1238S56
60	GTA-3838F60	GTA-3838S60	GTA-1238F60	GTA-1238S60
66	GTA-3838F66	GTA-3838S66	GTA-1238F66	GTA-1238S66
72	GTA-3838F72	GTA-3838S72	GTA-1238F72	GTA-1238S72
84	GTA-3838F84	GTA-3838S84	GTA-1238F84	GTA-1238S84



D.O.T. Reusable Hose Fittings

Male Connector



Part Number	Replaces Tectran	Hose I.D.	Pipe Thread
GTA-105	105	3/8"	1/4"
GTA-106	106	3/8"	3/8"
GTA-107	107	3/8"	1/2"
GTA-106-8	106-8	1/2"	3/8"
GTA-107-8	107-8	1/2"	1/2"

Male Connector Body



Part Number	Replaces Tectran	Hose I.D.	Pipe Thread
GTA-1021	1021	3/8"	1/4"
GTA-1031	1031	3/8"	3/8"
GTA-1041	1041	3/8"	1/2"
GTA-1031-8	1031-8	1/2"	3/8"
GTA-1041-8	1041-8	1/2"	1/2"

Male Connector With Spring Guard



Part Number	Replaces Tectran	Hose I.D.	Pipe Thread
GTA-102	102	3/8"	1/4"
GTA-103	103	3/8"	3/8"
GTA-104	104	3/8"	1/2"
GTA-103-8	103-8	1/2"	3/8"
GTA-104-8	104-8	1/2"	1/2"

Adapter (Swivel Type & Crimped-On Fittings)



Part Number	Replaces Tectran	Pipe Thread	Use On Fitting No.
GTA-161201	161201	1/4"	1105
GTA-161201-6	161201-6	3/8"	1106
GTA-161201-8	161201-8	1/2"	1107
GTA-181201-6	181201-6	3/8"	1106-6
GTA-181201-8	181201-8	1/2"	1107-8

Female Swivel Connector With Adapter



Part Number	Replaces Tectran	Hose I.D.	Pipe Thread
GTA-1105	1105	3/8"	1/4"
GTA-1106	1106	3/8"	3/8"
GTA-1107	1107	3/8"	1/2"
GTA-1106-8	1106-8	1/2"	3/8"
GTA-1107-8	1107-8	1/2"	1/2"

Air Brakes



D.O.T. Reusable Hose Fittings Brass

Ferrule

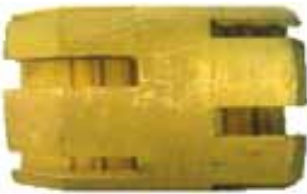

Part Number	Replaces Tectran	Hose I.D.
GTA-1022	1022	3/8"
GTA-1022-8	1022-8	1/2"

Union



Part Number	Replaces Tectran	Hose I.D.
GTA-105501	105501	3/8"
GTA-107701	107701	1/2"

Union Body



Part Number	Replaces Tectran	Hose I.D.
GTA-1055011	1055011	3/8"
GTA-1077011	1077011	1/2"

Spring Guard



Part Number	Replaces Tectran	Hose I.D.
GTA-1024	1024	3/8"
GTA-1024-8	1024-8	1/2"

Nut With Spring Guard



Part Number	Replaces Tectran	Hose I.D.
GTA-10234	10234	3/8"
GTA-10234-8	10234-8	1/2"

Nut - For use with spring guard



Part Number	Replaces Tectran	Hose I.D.
GTA-1023	1023	3/8"
GTA-1023-8	1023-8	1/2"

Hose Nut



Part Number	Replaces Tectran	Hose I.D.
GTA-1025	1025	3/8"
GTA-1025-8	1025-8	1/2"



Air Brake Nylon Tubing (OEM USE)

- For air brake systems only- NOT for fuel line applications
- SAE Type A tubing is single wall extruded nonreinforced nylon
- SAE Type B tubing has seamless extruded nylon core with fiber reinforced protective nylon cover
- Can be used with either air brake or nylon tube fittings
150 psi maximum working pressure
- UV and ozone resistant nylon material
- Withstands temperatures of -40 to +200 F

Quality Testing Requirements

- Meets or Exceeds SAE J844 type "A" & "B" specifications
- Meets or Exceeds FMVSS 106
- Meets or Exceeds DOT requirements

Part No.	Color	Length	Nominal O.D.	SAE Type
GTA-1922-01	Black	1000' Bulk	1/8"	A
GTA-1922-01-1	Black	100' Coil	1/8"	A
GTA-19225-01	Black	1000' Bulk	5/32"	A
GTA-19225-01-1	Black	100' Coil	5/32"	A
GTA-1923-01	Black	1000' Bulk	3/16"	A
GTA-1923-01-1	Black	100' Coil	3/16"	A
GTA-1924-01	Black	1000' Bulk	1/4"	A
GTA-1924-01-1	Black	100' Coil	1/4"	A
GTA-1924-02	Blue	1000' Bulk	1/4"	A
GTA-1924-02-1	Blue	100' Coil	1/4"	A
GTA-1924-04	Green	1000' Bulk	1/4"	A
GTA-1924-04-1	Green	100' Coil	1/4"	A
GTA-1924-05	Red	1000' Bulk	1/4"	A
GTA-1924-05-1	Red	100' Coil	1/4"	A
GTA-1924-07	Yellow	1000' Bulk	1/4"	A
GTA-1924-07-1	Yellow	100' Coil	1/4"	A
GTA-1926-01	Black	500' Bulk	3/8"	B
GTA-1926-01-1	Black	100' Coil	3/8"	B
GTA-1926-02	Blue	500' Bulk	3/8"	B
GTA-1926-02-1	Blue	100' Coil	3/8"	B
GTA-1926-04	Green	500' Coil	3/8"	B
GTA-1926-04-2	Green	100' Coil	3/8"	B
GTA-1926-05	Red	500' Bulk	3/8"	B
GTA-1926-05-1	Red	100' Coil	3/8"	B
GTA-1926-07	Yellow	500' Bulk	3/8"	B
GTA-1926-07-1	Yellow	100' Coil	3/8"	B
GTA-1928-01	Black	500' Bulk	1/2"	B
GTA-1928-01-1	Black	100' Coil	1/2"	B
GTA-1928-02	Blue	500' Bulk	1/2"	B
GTA-1928-02-1	Blue	100' Coil	1/2"	B
GTA-1928-05	Red	500' Bulk	1/2"	B
GTA-1928-05-1	Red	100' Coil	1/2"	B
GTA-1928-07	Yellow	500' Bulk	1/2"	B
GTA-1928-07-1	Yellow	100' Coil	1/2"	B
GTA-1930-01	Black	250' Bulk	5/8"	B
GTA-1930-01-1	Black	100' Coil	5/8"	B
GTA-1930-04-1	Green	100' Coil	5/8"	B
GTA-1932-01	Black	250' Bulk	3/4"	B
GTA-1932-01-1	Black	100' Coil	3/4"	B

Type "A"
Single Wall Tubing
1-Layer of Nylon



Type "B"
Reinforced Fiber Wall Tubing
2-Layers of Nylon





Fast Fix Hose Repair Kit



Swivel Hose End Kits

Part Number	Replaces Tectran No.	Thread
GTA-5342	70-31402	3/8" NPTF
GTA-5343	70-31403	1/2" NPTF

Part No.	Hose ID	Pipe Thread	Thread Seal
GT-5342	3/8	3/8	No
GT-5343	3/8	1/2	No

A New Solution for Repairing Damaged Rubber Air Lines



Including	Two nylon shells provide corrosion resistant to improve air system life	One brass fitting with NPTF thread and coating provides tight connection	One assembly ring offers a tight crimping.	One wrench offers a easy installation and reduce residual torque.	One nylon hose barb takes a strong grasp to the rubber hose.
Assembly	Step 1. Cut off the damaged end of the hose. Position hose end on the inside groove of the shell. 	Step 2. Insert the brass fitting into the lock shell. 	Step 3. Assemble the other side of the shell onto the brass fitting and the hose. 	Step 4. Slide the assembly ring over the shell to its final position on the shell. 	Step 5. Insert nylon barb into the fitting, turn and push it with the wrench until flush inside the fitting.

Notice:

1. Greasing the nylon barb before inserting it into the fitting.
2. Check final assembly visually to insure that hose has not shifted position during assembly.

Heavy Duty Drain Valve

GT-5300

- 60" cable with 1/4" pipe thread (includes brass valve and cable)
- Replaces Phillips Part No. 12-820



NYLON TUBE CUTTER





GTA-SC1



Part Number	Description	Replaces Tectran
GT-5256	Nylon Tube Cutter	SC-1



Clamping Studs

Clamping Studs	Part No.	A	B	C	Length	Replaces Sloan	Replaces Tectran	Replaces Tramec
	GT-5251	1/2-14 NPTF	1-14 UNS	1/4-18 NPTF	2-7/8	S600	115-88	50010
	GT-5252	1/2-14 NPTF	1-14 UNS	1/2-14 NPTF	2-3/8	S629		50012
	GT-5253	1/2-14 NPTF	1-14 UNS	3/8-18 NPTF	1-11/16	S620	115-86	50001
	GT-5255	3/8-18 NPTF	1-14 UNS		1-5/16	S607	114-66	50006
	GT-5254	1/4-18 NPTF	3/4-16 UNS		1-1/2	S661	114B-44	50005
	GT-5256	1/2 O.D. Tube	7/8-20 UNF	3/8-18 NPTF	1-5/16	S608	113-8AB	50008
	GT-5257	3/8 O.D. Tube	7/8-20 UNF	3/8-18 NPTF	1-3/8	S609	113-6AB	50009

Slider Bars & Tracker Bar Replacement Parts

- Type 304 stainless steel 3/4" diameter
- Elongated mounting holes cover a range of mounting hole locations

Part No.	A	B	L	Description
GT-5421	20"	10.5"	21.5"	Material: 0.750 Inch O.D. X18GA. 304s.s.Tube
GT-5422	31.5"	22.9"	33.9"	
GT-5423	37.5"	28"	39"	
GT-5424	42.5"	33"	44"	
GT-5425	49.5"	40"	51"	

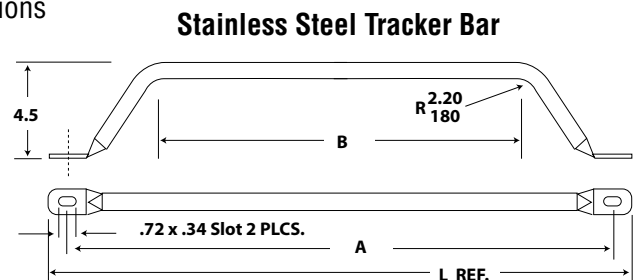

Part Number	Description	Replaces Phillips
GT- 5426	Kit with 39" bar & 20" spring	17-249

- Back of cab cable support
- Kits include bar, snap-on clip, sleeve, 3-hose holder and spring
- Stainless steel bar



GT-5426



Hose Tender Kits



Part Number	Description	Replaces Tectran
GT- 5427	16" Double Spring Tube Holder	9820-2
GT- 5014	16" Single Spring Tube Holder	9820-1
GT- 5015	25" Double Spring Tube Holder	9821-2
GT- 5016	25" Single Spring Tube Holder	9821-1

Each kit is complete with:

- Large snap clip
- Protective sleeve
- Heavy Duty spring
- Hefty clamp hanger
- Slide rings on double kits

Part Number	Description	Replaces Phillips
GT- 5375	Kit with single heavy-duty spring, 20"holder	17-148

- Replacement spring and hardware for tracker bars
- Kits include snap-on clip, sleeve, 3-hose holder and spring (s)
- Ideal for ABS cable use

Part Number	Description	Replaces Tectran
GT-5013	Extreme 3 Hose Holder w/Eyebolt/U-Bolt	94001

Part Number	Description	Replaces Phillips
GT- 5007	3" spring with tandem frame clip, 3/4" O.D.	17-103
GT- 5008	6" spring, 1" O.D.	17-106

- For use on trailers with sliding axles
- Supports air lines to rear axle

Part Number	Description	Replaces Phillips
GT- 5001	11" tandem cable and air line support	17-111
GT- 5002	13" tandem cable and air line support	
GT- 5003	16" recommended for straight cable assemblies	17-116
GT- 5004	20" extra heavy-duty, for use with ABS coiled assemblies	17-120
GT- 5006	25", extra heavy-duty, for use with ABS coiled assemblies	17-125

- Pre-galvanized hard drawn wire per SAE-ASTM-A227-77
- All springs are 1" O.D.



GT-5375



GT-5013





Gladhand & Plug Stow Away Holders



Part Number	Description	Replaces Tectran
GT-5391	Gladhand & Plug Stow Away Holder 1 Slot	9409
GT-5392	Gladhand & Plug Stow Away Holder 2 Slots	9409-2

Hose Separators

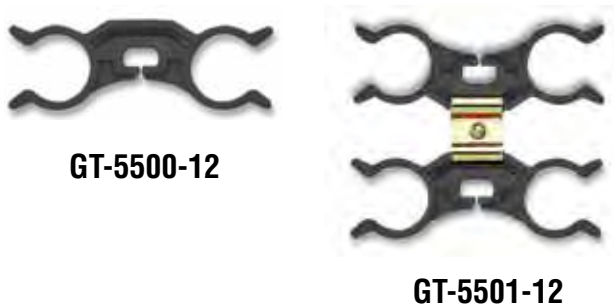

- Keeps nylon air hose secure and out of the way
- For 3/8" hose size
- For tractor coiled air, trailer slider hose applications

Part Number	Description	Replaces Phillips
GT-5500-12	2 Hose 1/2" separator	17-150
GT-5500-38	2 Hose 3/8" separator	17-150
GT-5501-12	4 Hose 1/2" separator	17-151
GT-5501-38	4 Hose 3/8" separator	17-151

Hose Holders



Part Number	Description	Replaces Phillips
GT-5001-2	2-Hose holder, .75" hole size	17-156
GT-5001-3	3-Hose holder, .75" hole size	17-157
GT-5001-4	4-Hose holder, .75" hole size	17-158

Slider Hose Undercarriage Tender Kits

Complete with:

- Beam clip GT-5012
- Heavy Duty spring
- 2 or 3-Hole clamp hanger (5001-2, 5001-3)

Part Number	Description
GT-5010	13" Heavy Duty spring with 2-hole clamp
GT-5011	13" Heavy Duty spring with 3-hole clamp



Beam Clip





Pogo Sticks

A complete line of Pogo Sticks to fit all needs, no matter what the height requirement is or material.

- Zinc Dichromate
- Chrome
- Stainless Steel (Type 304SS)
- Black Powder-Coated

Zinc Dichromate Pogo Sticks

Part No.	Length	Description	Replaces Tectran
GT-5380	24"	Yellow Zinc	9400D-2
GT-5370	40"	Yellow Zinc	9400E-2
GT-5381	50"	Yellow Zinc	9400L-2

Chrome Pogo Sticks

Part No.	Length	Description	Replaces Tectran
GT-5382	24"	Chrome	9400F-2
GT-5371	40"	Chrome	9400G-2
GT-5383	50"	Chrome	9400M-2

Stainless Steel (Type 304SS) Pogo Sticks Pogo Sticks

Part No.	Length	Description	Replaces Tectran
GT-5384	24"	Stainless Steel	9400J-2
GT-5385	40"	Stainless Steel	9400H-2

Black Pogo Sticks

Part No.	Length	Description
GT-5372	40"	Black Powder-Coated





OEM Clevis Assemblies

GT-5403

MERITOR STYLE



<u>Thread</u>	<u>Clevis Pin</u>	<u>Pin Dia.</u>	<u>Pack Size</u>
5/8"-18	1/2"	1/4"	4/EA

GT-5404

GUNITE STYLE



<u>Thread</u>	<u>Clevis Pin</u>	<u>Pin Dia.</u>	<u>Pack Size</u>
M 16 X 1.5	12.0 mm	6.0 mm	4/EA

GT-5405

BENDIX STYLE



<u>Thread</u>	<u>Clevis Pin</u>	<u>Pin Dia.</u>	<u>Pack Size</u>
5/8"-18	1/2"	1/4"	4/EA

GT-5406

CREWSON STYLE



<u>Thread</u>	<u>Clevis Pin</u>	<u>Pin Dia.</u>	<u>Pack Size</u>
5/8"-18	1/2"	1/4"	4/EA

Clevis Assembly



Pack Size
50/EA

Part #	Thread	Pin	Length	Replaces
GT-5400	5/8"	1/2"	2-3/8"	KN36470
GT-5401	1/2"	1/2"	2-3/8"	
GT-5402	5/8"	5/8"	2-3/8"	
Part #	Description			
GT-5400A	clevis yoke 5/8", replacement yoke for GT-5400			
GT-5400B	clevis pin 1/2", replacement yoke for GT-5400			
GT-5400C	cotter pin, fits all available clevis pins			
GT-5402A	clevis yoke 1/2", replacement yoke for GT-5402			
GT-5402B	clevis pin 5/8", replacement pin for GT-5402			

Individual parts for OEM use:



Selecting a Slack Adjuster

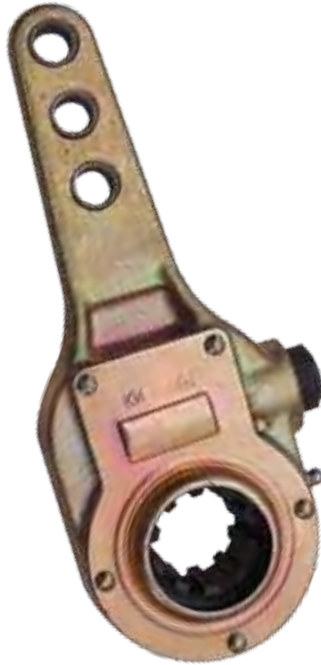

1. Determine if straight or offset arm If offset determine if RH or LH needed.
2. Identify spline size (diameter and number of teeth).
3. Select model needed.
4. Determine the arm hole used (if slack contains more than one).
5. Identify bushing diameter.
6. Measure from center of arm hole used to center of splined hole to determine arm length (A).

All Globetech slacks meet the following criteria:

TS16949 Certified
 Meet SAE J1461-91 & SAE Ji512-90 Standards
 Torque Rating:
 20,000 - 26,000 inch lbs.
 or 2,300 - 3,000 Newton Meter
 Life time: More than 200,000 cycles

Manual Straight Arm Slack Adjusters Without Clevis

	Part Number	Spline	A	B	C	Replaces
	GTA-KN44051	1-1/2" - 28	5"	6"		Batco 05-328 Bendex BWP M-638 Euclid Leland Meritor Midland Norforge Spicer Sirco S2011A
	GTA-KN44071	1-1/2" - 28	5"	6"	7"	Batco Bendex 286965 BWP M-3373 Euclid E-2458S Leland L-1308EC Meritor R824003 Midland KN44071 Norforge A-7085 Spicer 10-355 Sirco S2022A



Manual Straight Arm Slack Adjusters Without Clevis

	Part Number	Spline	A	B	C	Replaces
	GTA-KN44061	1-1/2" - 28	5-1/2"	6-1/2"		Batco 05-237 Bendex 288753 BWP M-2577 Euclid E-2459S Leland L-1648EC Meritor R824004 Midland KN44051 Norforge A-7094 Spicer 10-368 Sirco S2019A
	GTA-KN51010	1-1/2" - 28	6"			Batco 05-251 Bendex BWP M-3374 Euclid E-5498 Leland L-2349 Meritor A3275J686 Midland KN51010 Norforge A-7228 Spicer Sirco S2023
	GTA-KN44041	1-1/2" - 37	6"			Batco 05-240 Bendex 283411 BWP M-474 Euclid E-1574S Leland L-841EC Meritor R824007 Midland KN44041 Norforge A-7100 Spicer 10-367 Sirco S2012A
	GTA-KN48031	1-1/4" - 10	4-1/2"	5-1/2"		Batco 05-214 Bendex 278302 BWP M-3375 Euclid E-4904 Leland L-2494 Meritor R822009 Midland KN8031 Norforge A-7134 Spicer 10-399 Sirco S2026

Curved Arm For 12-1/4" "Q" Brakes

For all 1-1/4" - 10 Spline Camshafts

Air Brakes



Manual Slack Adjusters

- Zinc-Dichromate Finish
- Positive Locking Adjustment
- Heat Treated Alloy Gears
- Threaded Grease Fitting
- Bi-Directional Body Design

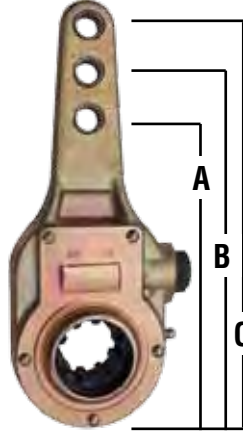
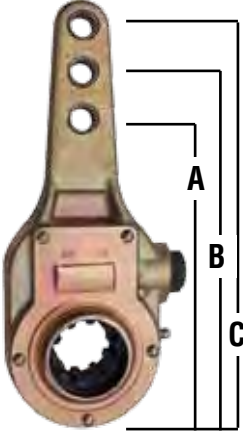

Part Number	Spline	A	B	C	Replaces
GTA-KN55001	1-1/4" - 24	5-1/2"			Batco 05-254
					Bendex M-3984
For Meritor 15" x 4" "Q" Brakes					
GTA-KN47081	1-1/2" - 10	5"	6"		Batco 278010
					Bendex M-452
GTA-KN47001	1-1/2" - 10	5"	6"		Batco 278010
					Bendex M-452
GTA-KN47011	1-1/2" - 10	5-1/2"	6-1/2"		Batco 05-201
					Bendex 278321
GTA-KN51000	1-1/2" - 10	6"			Batco 05-250
					Bendex 278084
Curved Arm For 12-1/4" Brakes					

all references to competitors' part numbers are for cross reference purposes only







Automatic Slack Adjusters



Part Number	Spline	Arm Length	Replaces
GTA-065164	1-1/4" - 10	5-1/2"	Bendex 065164 Gunitite AS1136/AS1152 Midland CS56036 Sirco SA2164
GTA-065167	1-1/4" - 24	5-1/2"	Bendex 065167 Gunitite AS1138/AS1154 Midland CS56038 Sirco SA2167
GTA-065170	1-1/2" - 10	5-1/2"	Bendex 065170 Gunitite AS1132/AS1147 Midland CS56032 Sirco SA2170
GTA-065172	1-1/2" - 10	6"	Bendex 065172 Gunitite AS1133/AS1146 Midland CS56033 Sirco SA2172
GTA-065174	1-1/2" - 28	6"	Bendex 065174 Gunitite AS1140/AS1149 Midland CS56040 Sirco SA2174
GTA-065175	1-1/2" - 28	6"	Bendex 065175 Gunitite AS1141/AS1151 Midland CS56041 Sirco SA2175
GTA-065178	1-5/8" - 37	5-1/2"	Bendex 065178 Gunitite Midland CS56043 Sirco SA2178
GTA-065179	1-5/8" - 37	6"	Bendex 065179 Gunitite AS1144 Midland CS56044 Sirco SA2179
GTA-R801073	28 DIA. 1-1/2"	Drillings 5.5"	Meritor R801073
GTA-R801074	28 DIA. 1-1/2"	Drillings 6"	Meritor R801074





Automatic Slack Adjusters

	Part Number	Spline	A	B	C	Replaces
	GTA-40010144	1-1/2" - 28	6"			Batco Bendex BWP Euclid Leland Meritor Midland Norforge Spicer Sirco E-6918A R806016 40010144 SA10144
			For Mack Drive Axles			
	GTA-40010142	1-1/2" -10	5" - 6"			Batco Bendex BWP Euclid Leland Meritor Midland Norforge Spicer Sirco E-6923B R806023 40019142 SA10102
			For Standard Drive Axle Brakes			
	GTA-40010143	1-1/2" -10	5-1/2" - 6-1/2"			Batco Bendex BWP Euclid Leland Meritor Midland Norforge Spicer Sirco E-6924B R806022 SA10103
			For Standard Drive Axle Brakes			
	GTA-40010140	1-1/2" -28	5" - 6"			Batco Bendex BWP Euclid Leland Meritor Midland Norforge Spicer Sirco E-6925B R806024 SA10100
			For Standard Drive Axle Brakes			



Automatic Brake Adjusters

	Part Number	Spline	Arm Length	Replaces
 	GTA-40010141	1-1/2" - 28	5-1/2" - 6-1/2"	Batco Bendex BWP Euclid E-6927B Leland Meritor R806004/26 Midland 40010141 Norforge Spicer Sirco SA10101
		For Standard Drive Axle Brakes		
	GTA-40010306	1-1/2" - 10	6"	Batco Bendex BWP Euclid E-6928 Leland Meritor R806007 Midland 40010306 Norforge Spicer Sirco SA10306
		For 12-1/4" Trailer Axle Brakes		
	GTA-40010305	1-1/2" - 28	6"	Batco Bendex BWP Euclid E-6933 Leland Meritor R806006 Midland 40010305 Norforge Spicer Sirco SA10305
	For 12-1/4" Trailer Axle Brakes			
	GTA-40010215	1-1/2" - 10	5-1/2"	Batco Bendex BWP Euclid E-6940 Leland Meritor R806021 Midland 40010215 Norforge Spicer Sirco SA10215
	For 16-1/2" Trailer Axle Brakes			
	GTA-40010216	1-1/2" - 10	6"	Batco Bendex BWP Euclid E-6936 Leland Meritor R806015 Midland 40010216 Norforge Spicer Sirco SA10216
	For 16-1/2" Trailer Axle Brakes			



Automatic Brake Adjusters

	Part Number	Spline	Arm Length	Replaces
	GTA-40010211	1-1/2" - 28 <div style="border: 1px solid black; padding: 2px; text-align: center;">For 16-1/2" Trailer Axle Brakes</div>	5-1/2"	Batco Bendex BWP Euclid Leland Meritor Midland Norforge Spicer Sirco E-6944 R806019 40010211 SA10211
	GTA-40010212	1-1/2" - 28 <div style="border: 1px solid black; padding: 2px; text-align: center;">For 16-1/2" Trailer Axle Brakes</div>	6"	Batco Bendex BWP Euclid Leland Meritor Midland Norforge Spicer Sirco E-6942 R806013 40010212 SA10212
	GTA-40010214	1-5/8" - 37 <div style="border: 1px solid black; padding: 2px; text-align: center;">For 16-1/2" Fruehauf Trailer Axle Brakes</div>	6"	Batco Bendex BWP Euclid Leland Meritor Midland Norforge Spicer Sirco E-6946 R806014 40010214 SA10214

Globetech Slack Adjusters are manufactured to OEM standards
Automatic Slack Adjusters available to replace: Crewson, Bendix, Haldex and Meritor



Crewson Style Standard Automatic Slack Adjusters

Part No.	Replaces Crewson	Chamber Size	Spline Size	Clevis	Arm Length
GTA-21102	21102	ALL	1-1/2"-10	5/8"-18 STR	5.5, 6.5
GTA-21103	21103	ALL	1-1/2"-10	5/8"-18 STR	5.0, 6.0
GTA-22102	22102	ALL	1-1/2"-28	5/8"-18 STR	5.5, 6.5
GTA-22103	22103	ALL	1-1/2"-28	5/8"-18 STR	5.0, 6.0
GTA-23102	23102	ALL	1-5/8"-37	5/8"-18 STR	5.5, 6.5
GTA-24100	24100	ALL	1-1/4"-10	5/8"-18 STR	5.5, 6.5
GTA-24102	24102	ALL	1-1/4"-10	5/8"-18 STR	5.5, 6.5
GTA-24103	24103	ALL	1-1/4"-10	5/8"-18 STR	5.0
GTA-25100	25100	ALL	1-1/4"-10	5/8"-18 STR	5.5
GTA-25102	25102	ALL	1-1/4"-24	5/8"-18 STR	5.5, 6.5
GTA-25103	25103	ALL	1-1/4"-24	5/8"-18 STR	5.0, 6.0

Crewson Style Auto-Check Slack Adjusters

Part No.	Replaces Crewson	Chamber Size	Spline Size	Clevis	Arm Length
GTA-34100	34100	20/24	1-1/4"-10	5/8"-18 STR	5.5
GTA-34200	34200	16	1-1/4"-10	1/2"-20 STR	5.5
GTA-35100	35100	20/24	1-1/4"-24	5/8"-18 STR	5.5
GTA-35200	35200	16	1-1/4"-24	1/2"-20 STR	5.5
GTA-41100	41100	30	1-1/2"-10	5/8"-18 STR	5.5
GTA-41106	41106	30	1-1/2"-10	5/8"-18 STR	6.0
GTA-42100	42100	30	1-1/2"-28	5/8"-18 STR	5.5
GTA-42106	42106	30	1-1/2"-28	5/8"-18 STR	6.0
GTA-43100	43100	30	1-5/8"-37	5/8"-18 STR	5.5
GTA-43106	43106	30	1-5/8"-37	5/8"-18 STR	6.0



The auto-check stroke indicator attaches to the automatic brake adjuster; which eliminates the need to crawl under vehicles to determine air chamber stroke. Not interchangeable with other slack adjusters.



Slack Adjuster Cross Reference

Haldex/Midland	Manual Globetech	Page No.	Automatic Bendix	Globetech	Page No.
KN44041	GTA-44041	106	065164	GTA-065164	111
KN44051	GTA-44051	105	065167	GTA-065167	111
KN44061	GTA-44061	106	065170	GTA-065170	111
KN44071	GTA-44071	105	065172	GTA-065172	111
KN47001	GTA-47001	107	065174	GTA-065174	111
KN47011	GTA-47011	107	065175	GTA-065175	111
KN47081	GTA-47081	107	065178	GTA-065178	111
KN48031	GTA-48031	106	065179	GTA-065179	111
KN51000	GTA-51000	108	Meritor	Globetech	Page No.
KN51010	GTA-51010	106	R801073	GTA-R801073	111
KN55001	GTA-55001	107	R801074	GTA-R801074	111
Haldex/Midland	Automatic Globetech	Page No.	Crewson	Globetech	Page No.
40010140	GTA-40010140	108	21102	GTA-21102	112
40010141	GTA-40010141	109	21103	GTA-21103	112
40010142	GTA-40010142	108	22102	GTA-22102	112
40010143	GTA-40010143	108	22103	GTA-22103	112
40010144	GTA-40010144	108	23102	GTA-23102	112
40010144	GTA-40010144	108	24100	GTA-24100	112
40010211	GTA-40010211	110	24102	GTA-24102	112
40010212	GTA-40010212	110	24103	GTA-24103	112
40010214	GTA-40010214	110	25100	GTA-25100	112
40010215	GTA-40010215	109	25102	GTA-25102	112
40010216	GTA-40010216	109	25103	GTA-25103	112
40010305	GTA-40010305	109	34100	GTA-34100	112
40010306	GTA-40010306	109	34200	GTA-34200	112
			35100	GTA-35100	112
			35200	GTA-35200	112
			41100	GTA-41100	112
			43106	GTA-41106	112

Parts listed in this catalog are not necessarily manufactured by the original equipment manufacturer and any reference to the trademarks or part numbers of others are for cross reference informational purposes only. The photos provided herein are provided only for illustrative purposes. The actual products supplied may differ. The trademarks of others referred to herein are owned by their respective companies and are not affiliated in any way with Globetech Manufacturing Inc. No representation is made with respect to the source of manufacturer of any particular part. While every efforts is made to provide accurate information, no guarantee is provided as to the accuracy of the information contained herein. We are not responsible for typographical errors.

Valve Index

Bendix	Globetech	Haldex	Globetech
284412 (DV-2)	GTA-284412	KN16743	GTA-16743
277863 (E-3)	GTA-277863	KN23000	GTA-23000
286171 (E-6)	GTA-286171	KN20030	GTA-20030
286773 (E-7)	GTA-283773	KN20031	GTA-20031
280479 (DC-1)	GTA-280479	KN28600 (FF-2)	GTA-28600
278414 (DC-4)	GTA-278414	KN28601 (FF-2)	GTA-28601
278415 (DC-4)	GTA-278415	KN20541	GTA-20541
276566 (PP-1)	GTA-276566	KN26000	GTA-26000
276567 (PP-1)	GTA-276567	KN27000	GTA-27000
280479 (DC-1)	GTA-280479	KN3546	GTA-3546
229635	GTA-229635	KN28500	GTA-28500
275491 (D-2)	GTA-G8602	KN28510	GTA-28510
279472 (LP-3)	GTA-279472	KN28520	GTA-28520
228750 (LP-3)	GTA-228750	KN30300	GTA-30300
288239 (PP-7)	GTA-288239	KN30400	GTA-30400
065066 (QR-N)	GTA-065066	KN4688	GTA-4688
065067 (QR-N)	GTA-065067		
229859 (QR-1A)	GTA-229859	Neway	Globetech
229860 (QR-1B)	GTA-229860	K910058	GTA-910058
289714 (QR-1C)	GTA-289714	90054007	GTA-90054007
289182 (QR-1C)	GTA-289182	90554241	GTA-90554241
065104 (R-12)	GTA-065104	90554243	GTA-90554243
102626 (R-12)	GTA--102626	90054079	GTA-90054079
103009 (R-12)	GTA-103009	90054088	GTA-90054088
103028 (R-14)	GTA-103028	90054107	GTA-90054107
103010 (R-14)	GTA-103010	90054074	GTA-90054074
281865 (RE-6)	GTA-281865	90054075	GTA-90054075
065145 (BP-R1)	GTA-065145	90054076	GTA-90054076
065146 (BP-R1)	GTA-065146		
286370 (R-8)	GTA-286370	Sealco	Globetech
131081 (ST-4)	GTA-131081	110500	X-5
284143 (ST-3)	GTA-284143	110700	GTA-110700
205105 (ST-1)	GTA-205105	110800	GTA-110800
065437 (SR-5)	GTA-065437	17600B	GTA-17600
065439 (SR-5)	GTA-065439	110170	GTA-110170
102761 (SR-2)	GTA-102761	110171	GTA-110171
228600 (SL-4)	GTA-228600	140280	GTA-140280
101112 (SR-4)	GTA-101112	140270	GTA-140270
101622 (SR-4)	GTA-101622	996555	GTA-996555
279000 (TP-3)	GTA-279000	110415	GTA-110415
		110380	GTA-110380
Fuller	Globetech	110197	GTA-110197
A-470	GTA-A-470	110139	GTA-110139
A-5000	GTA-A-5000	110410	GTA-110410
Midland	Globetech	21600	GTA-21600
12353	GTA-12352	110515	GTA-110515
		616	GTA-616
		110191	GTA-110191
		17600B-1	GTA-17600B-1
		110376	GTA-110376
		110205	GTA-110205
		2550	GTA-2550



Air Regulator Valves



All ports: 1/8" NPT
 Non-adjustable preset
 at 57-65 PSI
 Replaces: Haldex KN16743

Part Number	Description
GTA-16743	Oil regulator valve

Automatic Reservoir Drain Valves



Overall height: 2-3/8"
 Overall width: 3-3/4"
 Port A: 3/8" PT
 Port B: 3/8" PT
 Adapter: 1/4" PT
 Replaces: Bendix 284412 (DV-2)

Part Number	Description
GTA-284412	Automatic reservoir drain valve

Brake Valves



Overall height: 4-5/16"
 Delivery Ports: (4) 1/2" PT
 Auxiliary Ports: none
 Replaces: Bendix 277863 (E-3)

Part Number	Description
GTA-277863	Brake valve (basic)



Overall height: 5-5/8"
 Supply Ports: (2) 3/8" PT
 Delivery Ports: (2) 3/8" PT
 Exhaust at bottom
 Replaces: Bendix 286171 (E-6)

Part Number	Description
GTA-286171	Dual brake valve with pedal

CAB Control Valves



*Overall height: 5-1/16"
 Rear ports: (4) 1/2"
 Side Ports: (8) 1/4"
 Mounting Studs: (3) 1-1/2" L
 Replaces: Bendix 286773 (E-7)

Part Number	Description
GTA-286773*	Dual brake valve (basic) 3 mounting bolts installed
GTA-286771	Dual brake valve (basic)



Delivery Port: 1/4" NPT
 Supply Port: 1/4" NPT
 Exhaust Port: 1/4" non-threaded
 Push/pull, hand control
 Knob/name plate not included
 Replaces: Sealco 17600

Part Number	Description
GTA-17600	CAB control valve



Check Valves & Control Valves



Length: 2.47"
 Inlet/Outlet: 1/2"
 Style: Heavy Duty
 Replaces: Haldex KN23000



3 ports: Pipe thread dimension 3/8" (all ports)
 Replaces: Bendix 280479 (DC-1)

Part Number	Description
GTA-23000	Single check valve, 1/2"
GTA-23800	Single check valve, 3/8"

Part Number	Description
GTA-280479	Double check valve



GTA-278614: 3 ports, pipe thread dimension 3/8"
 Replaces: Bendix 278614 (DC-4)
 GTA-278615: 3 ports, pipe thread dimension 1/4"
 Replaces: Bendix 278615 (DC-4)



Body height: 2-1/2"
 Delivery ports: (2) 1/8" PT
 Supply ports: (1) 1/8" PT
 Lever: Steel with Chrome Finish
 Replaces: Bendix 229635

Part Number	Description
GTA-278614	Double check valve
GTA-278615	Double check valve

Part Number	Description
GTA-229635	Control valve



Overall height: 3-19/32"
 Delivery ports: (2) 1/8" PT
 Supply ports: (1) 1/8" PT
 Automatic Release Pressure:
 GTA-276566 20 PSI
 GTA-276567 40 PSI
 Replaces: Bendix 276566 (PP-1)
 Bendix 276567 (PP-1)

Part Number	Description
GTA-276566	Control valve
GTA-276567	Control valve



Check Valves & Control Valves



Push/pull, hand operated
 Delivery port: 1/4"
 Supply port: 1/4"
 Exhaust port: 1/4" non threaded
 Replaces: Haldex KN20030
 KN20031



Part Number	Description
GTA-M7102	Dash control valve
GTA-M7102-K	Knobs only

Part Number	Description
GTA-20030	Dash control valve
GTA-20031	Dash control valve

Filter Assemblies



All ports: 1/8" NPT
 Non-adjustable
 Preset at 57-65 PSI
 Replaces: Fuller A-4740

Part Number	Description
GTA-A4740	Filter assembly

Full Function Valves



Spring brake ports: (2) 3/8"
 Service brake ports: (4) 3/8"
 Supply ports: (1) 3/8"
 Control ports: (1) 1/4"
 Reservoir ports: (1) GTA-28600 3/4"
 GTA-28601 1/2"
 Crack Pressure: 3 PSI
 Replaces: Haldex KN28600 (FF-2)
 KN28601 (FF-2)

Part Number	Description
GTA-28600	Full function valve
GTA-28601	Full function valve

Governors

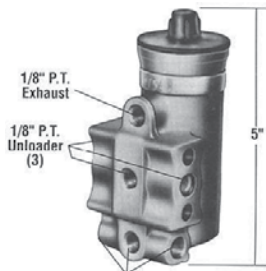

Pressure: 100-120 PSI,
 non-adjustable
 Replaces: Bendix 275491 (D-2)

Part Number	Description
GTA-G8602	Governor

Hand Control Valves



Delivery Port: 1/4"
 Supply Port: 1/4"
 Control Port: 1/4"
 Replaces: Haldex KN20541

Part Number	Description
GTA-20541	Hand control valve



Hand Control Valves



Auxiliary lift axle valve
2 positions, manual
Replaces: Neway K910058

Part Number	Description
GTA-910058	Hand control valve

Height Control Valves



Body constructed in Engineering Grape plastic
Horizontal arm length: 12" max
Vertical arm length: 14"
Axle bracket linkage: vertical
Replaces: Haldex KN27000

Part Number	Description
GTA-27000	Height control valve



Controlled response
Fittings provided: 1/4"
Exhaust port: 1/8"
Air Spring port: 1/8"
Supply port: 1/8"
Replaces: Neway 90054007

Part Number	Description
GTA-90054007	Height control valve



Max length: 14"
Replaces: Haldex 48100367
Tectran 80-1006AL

Part Number	Description
GT-Q500	Leveling link, 6 per box

Leveling Valves



Immediate Response
All ports: GTA-90554241 1/4" NPT
GTA-90554243 12mm x 1.5
Replaces: Neway 90554241
90554243

Part Number	Description
GTA-90554241	Leveling valve, (IR)
GTA-90554243	Leveling valve, (IR)

Low Pressure Indicators



Body height: 1-15/16"
Pipe Thread: 1/4"
Cut-out Pressure: GTA-279472 75 - 6
GTA-228750 60 - PSI
Single Terminal - GTA-279472
Double Terminal - GTA-228750
Replaces: Bendix 279472 (LP-3)
228750 (LP-3)

Part Number	Description
GTA-279472	Low pressure indicator
GTA-228750	Low pressure indicator



Multifunction Valves



Trailer spring brake valve
 Delivery ports: (4) 3/8" PT
 Supply ports: (1) 3/8" PT
 Reservoir (A): 1/2" PT
 Reservoir (B): 3/8" PT
 Control ports: (1) 3/8" PT
 Closing Pressure: 55 PSI
 Replaces: Haldex KN 26000 (RT-4)

Part Number	Description
GTA-26000	Multifunction valve

Pilot Valves



3 Way
 Replaces: Neway 90054079
 and 90054088

GTA-90054079 GTA-90054088

Part Number	Description
GTA-90054079	Pilot valve
GTA-90054088	Air suspension valve

Pressure Protection Valves



Williams style with filter
 Replaces: Neway 90054107
 Replaces: Williams WM778A1

Part Number	Description
GTA-90054107	Pressure protection valve

Push/Pull Valves



Overall height: 4-25/32"
 Delivery ports: (1) 1/4" PT
 Supply ports: (1) 1/8" PT
 Control ports: (1) 1/8" PT
 Automatic Release Pressure: 40 PSI
 Replaces: Bendix 288239 (PP-7)

Part Number	Description
GTA-288239	Push/Pull valve



All ports: 1/8" NPT
 Replaces: Haldex KN3546

Part Number	Description
GTA-3546	Push/pull type valve transmission range

Quick Release Valves



Overall height: 2-1/4"
 Delivery ports: (2) 3/8" PT
 Supply ports: GTA-065066 (1) 1/2"
 GTA-065067 (1) 3/8"
 Crack Pressure: 1 PSI
 Mounting holes: 11/32" dia., 1-1/2" C-C
 Replaces: Bendix 065066 (QRN)
 Bendix 065067 (QRN)

Part Number	Description
GTA-065066	Quick release valve
GTA-065067	Quick release valve



Quick Release Valves



Overall height: 2-1/2"
 Overall width: 3-1/4"
 Delivery ports: (2) 3/8" PT
 Supply ports: GTA-229859 (1) 3/8"
 GTA-229860 (1) 1/2"
 Crack Pressure: 1 PSI
 Mounting holes: 11/32" dia., 1-1/2" C-C
 Replaces: Bendix 229859 (QR-1A)
 Bendix 229860 (QR-1B)

Part Number	Description
GTA-229859	Quick release valve
GTA-229860	Quick release valve



Overall height: 2-11/16"
 Delivery ports: GTA-289714 (2) 3/8" PT
 GTA-289182 (2) 1/4" PT
 Supply ports: (1) 1/4" PT
 Balance: (1) 1/4" PT
 Mounting holes: 11/32" dia., 1-1/2" C-C
 Replaces: Bendix 289714 (QR-1C)
 Bendix 289182 (QR-1C)

Part Number	Description
GTA-289714	Quick release valve
GTA-289182	Quick release valve

Relay Valves



Body height: 3-7/8"
 Delivery ports: (4) GTA-065104 = 3/8" PT
 GTA-102626 = 1/2" PT
 Supply ports: (1) 1/2" PT
 Service ports: (1) 1/4" PT
 Crack Pressure: 4 PSI
 Replaces: Bendix 065104 (R-12)
 102626 (R-12)

Part Number	Description
GTA-065104	Relay valve, vertical ports
GTA-102626	Relay valve, vertical ports



Body height: 3-7/8"
 Delivery ports: (2) 1/2" PT
 Supply ports: (2) 3/4" PT
 Service ports: (1) 1/4" PT
 Crack Pressure: 4 PSI
 Replaces: Bendix 103009 (R-12)

Part Number	Description
GTA-103009	Relay valve, horizontal ports 3/4" G port



Body height: 4-7/16"
 Delivery ports: (4) 1/2" PT
 Supply ports: (1) 1/2" PT
 Service ports: (1) 1/4" PT
 Balance ports: (1) 1/8" PT - located
 beneath
 exhaust plate
 Crack Pressure: 4 PSI
 Replaces: Bendix 103028 (R-14)

Part Number	Description
GTA-103028	Relay valve, vertical ports



Body height: 4-7/16"
 Delivery ports: (2) 1/2" PT
 Supply ports: (2) 3/4" PT
 Service ports: (1) 1/4" PT
 Balance ports: (1) 1/8" PT - located
 beneath
 exhaust plate
 Crack Pressure: 4 PSI
 Replaces: Bendix 103010 (R-14)

Part Number	Description
GTA-103010	Relay valve



Relay Valves



Part Number	Delivery Ports (2)	Service/Control Ports (1)	Supply/Reservoir Port (A)	Supply/Reservoir (Port (B))	Control Position	Includes Plug	Replaces Haldex#
GTA-28500	3/8"	1/4" NPT	3/8"	3/8"	90°	(1) 3/8"	KN28500
GTA-28510	3/8"		3/8"	1/2"		(1) 1/2", (1) 3/8"	KN28510
GTA-28520	1/2"		1/2"	1/2"		(1) 1/2"	KN28520

RG-2 relay valve



Body height: 5-5/64"
 Delivery ports: (2) 1/4" PT
 APT Delivery: (2) 3/8" PT
 Supply ports: (A) 3/4" PT
 (B) 3/8" PT
 Service ports: (1) 1/4" PT
 Emergency ports: (1) 1/4" PT
 Replaces: Bendix 281865 (RE-6)



Service emergency relay valve (serv)
 For use on pre-121 trailers (before 1974)
 Crack Pressure: 4.5 PSI
 Replaces: Midland 12352

Part Number	Description
GTA-281865	Relay valve, emergency

Part Number	Description
GTA-12352	Relay valve



Delivery ports: (4) 3/8" NPT
 Supply ports: (1) 1/4" NPT
 Control ports: (1) GTA-110200 1/4" NPT
 GTA-110205 3/8" NPT
 Reservoir ports: (1) 3/4" NPT
 Ratio feature: yes
 Normal crack pressure: 4.5 PSI
 Replaces: Sealco 110200
 Sealco 110205



Overall height: 5-13/32"
 Delivery ports: (4) 3/8" PT
 Supply ports: (1) 1/2" PT
 Control ports: (1) 1/8" PT
 Service ports: (1) 1/4" PT
 Crack Pressure: GTA-065145 4 PSI
 GTA-065146 5.5 PSI
 Replaces: Bendix 065145 (BP-R1)
 Bendix 065146 (BP-R1)

Part Number	Description
GTA-110200	Relay valve, emergency
GTA-110205	Relay valve, emergency

Part Number	Description
GTA-065145	Relay valve, bobtail brake proportioning
GTA-065146	Relay valve, bobtail brake proportioning



Relay Valves

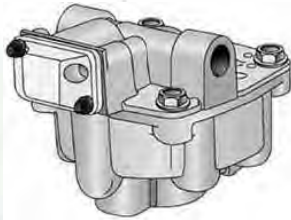

Delivery ports: (4) GTA-30300 1/4"
GTA-30400 3/4"
Reservoir ports: (1) 3/4"
Service inlet: (1) 1/4"
Emergency inlet: (1) 1/4"
Includes nipple
Crack Pressure: 3 PSI
Replaces: Haldex KN30300
KN30400

Part Number	Description
GTA-30300	Relay valve, emergency
GTA-30400	Relay valve, emergency



Delivery ports: (4) 3/8" NPT
Control ports: (1) 3/8" NPT
Reservoir ports: (1) 3/4" NPT
Normal crack pressure: 4 PSI
Replaces: Sealco 110415

Part Number	Description
GTA-110415	Relay valve. 4 port service



Supply port: 3/8" PT
Control port: 3/8" PT
Reservoir port A: 1/2" PT
Reservoir port B: 1/2" PT
Delivery port: 3/8"
Replaces: Sealco 110197

Part Number	Description
GTA-110197	Relay valve. 2 port service



Body height: 3-19/32"
Body width: 5-13/16"
Delivery ports: (2) 1/2" PT
Delivery ports: (1) 1/4" PT
Supply ports: (2) 3/4" PT
Service port: (1) 1/4" PT - located at 90°
Balance ports: (1) 1/8" PT - located under exhaust cover
Replaces: Bendix 286370 (R-8)

Part Number	Description
GTA-286370	Relay valve

Safety Valves Assemblies



Delivery Ports: (4) 1/4" NPT
Supply Ports: (1) 1/4" NPT
Control Ports: (1) 1/4" NPT
Reservoir Ports: (1) 1/2" NPT
Normal Crack Pressure: 1.5 PSI
Replaces: Sealco A10005

Part Number	Description
GTA-A10005	Relay valve with brass, emergency



Pressure: 250 PSI
Thread: 1/2" NPT
Holes: 1
Used with Tu-Flo 550 and 750 compressor
Replaces: Bendix 131081 (ST-4)

Part Number	Description
GTA-131081	Safety valve assembly



Safety Valves Assemblies



GTA-205105
 All ports: 1/4" NPT
 Replaces: Bendix 205105 (ST-1)
 GTA-284143
 PT: 3/8"
 Pressure setting: 150 PSI
 Replaces: Bendix 284143 (ST-3)

Part Number	Description
GTA-205105	Safety valve assembly
GTA-284143	Safety valve assembly

Solenoid Valves



GTA-90054074
 All ports: 1/4" NPT
 Replaces: Neway 90054074
 90054075

Part Number	Description
GTA-90054074	Solenoid valve (closed) directional control
GTA-90054075	Solenoid valve (open) directional control

Spring Brake Valves



12 volt direct current
 Manual override
 Universal - normally opened or closed
 Replaces: Neway 90054076

Part Number	Description
GTA-90054076	Solenoid valve directional control



Delivery ports: (4) 3/8" PT
 Service ports: (1) 1/4" PT
 Service/Spring brake reservoir: (1) 1/4" PT
 Trailer Supply: (1) 1/4" PT
 Trailer Service: (1) 1/4" PT
 Reservoir mounting: (1) GTA-065437 male 3/4" PT
 GTA-065439 male 1/2" PT
 Replaces: Bendix 065437 (SR-5)
 065439 (SR-5)

Part Number	Description
GTA-065437	Spring brake valve
GTA-065439	Spring brake valve



Delivery ports: (4) 3/8" NPT
 Supply ports: (1) 3/8" NPT
 Control ports: (1) 3/8" NPT
 Reservoir (A): 1/2" NPT
 Reservoir (B): GTA-110170 1/2" NPT
 GTA-110171 3/8" NPT
 Cover Rotate: GTA-110170 none
 GTA-110171 90 degrees
 Replaces: Sealco 110170
 110171

Part Number	Description
GTA-110170	Spring brake valve
GTA-110171	Spring brake valve



Body height: 4-3/16"
 Body width: 4-5/8"
 Delivery ports: (1) 1/4" PT
 Supply ports: (1) 1/4" PT
 Control ports: (1) 1/4" PT
 Reservoir ports: (1) 1/4" PT
 Reservoir Trip Pressure: 55 PSI
 Replaces: Bendix 286364 (SR-1)

Part Number	Description
GTA-286364	Spring brake valve



Spring Brake Valves



Body height: 5-17/32"
 Delivery ports: (4) 3/8" PT
 Trailer supply ports: (1) 1/4" PT
 Trailer service ports: (1) 1/4" PT
 Service reservoir ports: (2) 1/4" PT
 Reservoir connection: (1) 3/4" male PT
 Replaces: Bendix 102761 (SR-2)

Part Number	Description
GTA-102761	Spring brake valve

Stop Light Switches



Body height: 2-1/4"
 Body width: 1-5/8"
 Pipe thread: 1/4"
 Terminal thread: 8-32
 Replaces: Bendix 228600 (SL-4)

Part Number	Description
GTA-228600	Stop light switch



Body height: 5-3/4"
 Delivery ports: (4) 3/8" PT
 Reservoir charging ports: (2) 1/4" PT
 Trailer supply ports: (1) 1/4" PT
 Trailer service ports: (1) 1/4" PT
 Reservoir connection: (1) GTA-101112
 3/4" male PT
 GTA-101622 1/2" male PT
 Replaces: Bendix 101112 (SR-4)
 101622 (SR-4)

Part Number	Description
GTA-101112	Trailer spring brake valve
GTA-101622	Trailer spring brake valve



Body height: 4-3/4"
 Tractor service ports: 3/8" PT
 Tractor emergency ports: 1/4" PT
 Trailer service ports: 1/2" PT
 Trailer emergency ports: 1/2" PT
 Replaces: Bendix 279000 (TP-3)

Part Number	Description
GTA-279000	Tractor protection valve

Transmission Slave Valves



All ports: 1/8" NPT
 Replaces: Haldex KN4688

Part Number	Description
GTA-A4688	Transmission slave valve



All ports: 1/8" NPT
 Replaces: Fuller A-5000

Part Number	Description
GTA-A5000	Transmission slave valve

Air Brakes



Air Dryers



GTA-065612



GTA-109493



GTA-5001247

AD-IP Style Dryers & Components

Part Number	Description	Replaces
GTA-065612	AD-IP Style Dryer	065612
GTA-109493	AD-IP Style Cartridge	109493
GTA-5001247	AD-IP Style Bracket Kit	5001247



AD-9 Style Dryers & Components

Part Number	Description	Replaces
GTA-065225	AD-9 Style Dryer	065225
GTA-1065224	AD-9 Style 24 volt	065224
GTA-107796A	Desiccant Cartridge	107796
GTA-107695	Bracket Kit	107695
GTA-800405A	Purge Valve -12 volt	800405
GTA-5004338	Purge Valve -24 volt	5004338
GTA-5005037	Purge Valve -Kit	5005037
GTA-109578	Heater&Thermostat -12 Volt	109578
GTA-109579	Heater&Thermostat -24 Volt	109579
GTA-109869	Wiring Harness	109869
GTA-107800	Check Valve Kit - 1/2"	107800
GTA-107799	Check Valve Kit - 1/2"	107799
GTA-800350	Pressure Relief Valve	800350

- Long purge cycle and almost 4 lbs of desiccant ensures more contaminant & moisture removal
- Desiccant cartridge long life extends maintenance intervals
- Soft seat purge valve seal in all Air Dryers and Kits
- Cartridges & Kits include all replaceable O-Rings



GTA-5004341



GTA-107794



Air Dryers

Part Number	Description	Replaces
GTA-955205K	Model 1200 Dryer Kit 12v	R955205
GTA-955300	Model 1200P Dryer Only 12v	R955300

- Air Dryer for class 7 & 8 on-highway tractors
- Spin-on desiccant cartridge
- Cartridges and Kits include all replaceable O-Rings



GTA-955300



GTA-955205K



GTA-950011



GTA-1003100



GTA-33100

Part Number	Description	Replaces
GTA-950011	Desiccant Cartridge	R950011
GTA-950014	Purge Valve -Kit	R950014
GTA-950015	Heater Kit -12 volt	R950015
GTA-950002	Heater Harness	SRWABC002
GTA-950044	Regeneration Valve Kit	R950044
GTA-950045	Diaphragm for Regen. Valve	R950045
GTA-950017	Outlet Check Valve -Kit	5005037
GTA-1003100	Pressure Control Check Valve	S4341003100
GTA-1226	Pressure Relief Valve	S2206D1226
GTA-950013	Turbo Cut-Off Kit	R950013



GTA-950015



GTA-950044

Part Number	Description	Replaces
GTA-33100	Dryer Only 12v	DA33100

- Long purge cycle ensures more contaminant & moisture removal
- Easy desiccant cartridge removal
- Kits include all replaceable O-Rings
- New parts - no core charges



Air Dryers



GTA-6026

Part Number	Description	Replaces
; H5 !6026*	Dessicant Cartridge & Repair Kit	DQ6026
; H5 !6020Á	Lower Housing Kit	DQ6020
; H5 !6013	Heater Kit - 12 Volt	DQ6013
; H5 !31527Á	Pressure Relief Valve	KN31527



GTA-800404

Part Number	Description	Replaces
GTA-800404	Early Purge Valve Kit for Models IP & IS Dryers - 12 Volt	800404
GTA-022105	Late Purge Valve Kit for Models IP & IS Dryers	K022105



GTA-022105

Part Number	Description	Replaces
GTA-109495	Model IP & IS Dryers - 12 Volt	109495



GTA-109495

Part Number	Description	Replaces
GTA-88(1st Generation Cartridge T2000 dryer	VGG
GTA-88 !&	2nd Generation Cartridge T2000 dryer	VGG
GTA-%\$% \$\$	Cartridge for Model 2 Dryer	F€FJ€€
GTA-%\$(') ,	Cartridge for Model 4 Dryer	F€ H Í
GTA-%\$- - - (Cartridge for Model SP/IS Dryer	F€JJJI
GTA-\$*) * &	Cartridge for Model IP Dryer	€ Í Í G



Part Number	Description	Replaces
GTA-72420	Alcohol Evaporator	A72420
GTA-275491	Air Governor	275491
GTA-284358	High Temp Air Governor w/O-Rings	284358
GTA-281923	Non-Heated Drain Valve	281923
GTA-284412	Heated Drain Valve - 12 volt	284412



GTA-72420



GTA-281923



Part Number	Description
GTA-12102	2' Manual Drain Valve
GTA-12103	3' Manual Drain Valve
GTA-12104	4' Manual Drain Valve
GTA-12105	5' Manual Drain Valve
GTA-12105U	5' Manual Drain Valve -Uncrimped



Aluminum Gladhands



- Industry standard
- Aluminum cast body
- Steel clasp plate, rubber seal
- SAE J318 approved

Part Number	Description	Replaces Tramec#
GT-5330	universal	36301
GT-5331	emergency (red)	36201
GT-5332	service (blue)	36101

Ten to a box



Aluminum Swivel Gladhands



- Stainless steel spring & wear pad
- Steel mounting bracket zinc plated with yellow dichromate
- Includes brass airline fittings
- **“P” Powder Coated Swivel Iron Gladhand**

Part Number	Description	Replaces Tramec#
GT-5350-45	Gladhand - swivel only 45°	—
GT-5350-90	Gladhand - swivel only 90°	36390
GT-5351-45	Gladhand - swivel, emergency, 45°(red)	36281
GT-5351-90	Gladhand - swivel, emergency, 90°	36201
GT-5351P-45	Gladhand, swing-away, emergency, w/iron GH powder coated 45 degree	
GT-5351P-90	Gladhand, swing-away, emergency, w/iron GH powder coated 90 degree	
GT-5352-45	Gladhand service , 45 degree swing-away swivel assembly	36181
GT-5352-90	Gladhand service , 90 degree swing-away swivel assembly	36191
GT-5352P-45	Gladhand, swing-away, service, w/iron GH powder coated 45 degree	
GT-5352P-90	Gladhand, swing-away, service, w/iron GH powder coated 90 degree	
GT-5353	Iron swivel Gladhand red 'emergency' 1 piece cast	36233
GT-5354	Iron swivel Gladhand yellow 'service' 1 piece cast	36133

Iron Swivel Gladhands



GT-5354



Shut-off Gladhands



Knob Style



Lever Style

Part Number	Description	Replaces Tramec#	Replaces Phillips
GT-5338	emergency, shut-off Phillips	9212	12-310
GT-5338S	emergency, Sloan style, shut-off	9203	441014
GT-5339	service, shut-off Phillips	9211	12-306
GT-5339S	service, Sloan style, shut-off	9202	441004

37 Degree Bracket Mount Gladhands



GT-5317



GT-5327

3/8" – 18 NPTF ports with pipe plug

Part Number	Description	Replaces Phillips
GT-5317	service, 37° mounting	12-136
GT-5327	emergency, 37° mounting	12-138

Xtreme Gladhands



**GT-5333X
universal**



**GT-5334X
1 red 1 blue set**

Part Number	Description	Replaces Tramec
GT-5333X	Xtreme, aluminum, Universal	36301P
GT-5334X	Xtreme, red/blue SET	36201P & 36101P

- Powder-coated body - red/blue & black
- Stainless steel wear plate & clasp
- Urethane seal
- Stainless screen & screws
- Clamshell packaged



Cast Iron Gladhands



“V” Series

- Zinc plated, dichromated one piece
- Supplied with (GT-2600) rubber seal

Part Number	Description	Replaces Tramec#
GT-5335	Universal	56321
GT-5336	emergency	56221
GT-5337	service	56121

“Quick-E” Style Replacement



GT-5383

Quick Release

Part Number	Description	Replaces Phillips#
GT-5373	1/2" female pipe thread bottom port	12-206
GT-5374	3/8" female pipe thread bottom port with filter screen 37° Degree Trailer Mount	12-236

Poly Seal Kits

- Red & blue poly seal kits
- 2 seals per kit



Part Number	Description
GT-2609	Seal kit, double lip, large face combines GT-2606 & GT-2607
GT-2605GLO	Seal kit, small face combines GT-2601 & GT-2602
GT-2605WS	Gladhand seal kit with built-in filters small face, red/blue



Rubber Seals



Single Lip

Double Lip

Protecto

Part Number	Description	Replaces Tramec No.	Replaces Tectran No.
GT-2599	Single lip	36003	101112
GT-2600	Double lip	36001	10111
GT-2604	Protecto	–	101113

100 each per Poly Bag

Filters

GT-2601WS (red)

GT-2602WS (blue)

GT-2603WS (black)

- Urethane small face
- Stainless steel screen



(Bags 25 each to a bag)

Polyurethane Seals



Small Face



Large Face

Part Number	Description	Color	Replaces Tectran No.
GT-2601	Small face	Red	101115R
GT-2602	Small face	Blue	101115B
GT-2603	Small face	Black/Gray	101114
GT-2601WS	Small face with built in filter	Red	
GT-2602WS	Small face with built in filter	Blue	
GT-2603WS	Small face with built in filter	Black/Gray	
GT-2606	Large Face	Red	101119R
GT-2607	Large Face	Blue	101119B
GT-2608	Large Face	Black/Gray	101118

100 each per Poly Bag



Gladhand Locks



- Indestructible plastic body
- Stainless steel & zinc plated hardware
- Multiple key patterns available

Part Number	Description	Key	Replaces
GT-7200	Gladhand Lock and Key	GT-611K	1011LK
GT-7200-E100	Gladhand Lock and Key	GT-E100K	
GT-7200-E101	Gladhand Lock and Key	GT-E101K	

**ONE KEY FITS YOUR KING
PIN LOCK AND
GLANDHAND LOCK!
SECURE YOUR TRAILER
WITH TWO LOCKS ONE KEY!**



Part Number	Description
GT-611K	Keys only-set
GT-E100K	Keys only-set
GT-E101K	Keys only-set

Dummy Shutoff Gladhands



Die cast aluminum

Part Number	Description	Replaces Tramec#
GT-5345	w/stainless steel cable	1010-F18
GT-5345FX	red cable 21" long HD-eyelet	
GT-5348	red cable 11" long HD-eyelet	



red cable for GT-5348 & GT-5345FX

Dummy Coupling Mounts



Part Number	Description	Replaces Sloan#
GT-5347	Glaghand clear chromate Packaged 2 per bag	44731



Stamped

Part Number	Description	Replaces Tectran#
GT-5346V	Stamped steel vented	9412
GT-5346NV	Stamped steel non-vented	9411



Stainless Steel Screens

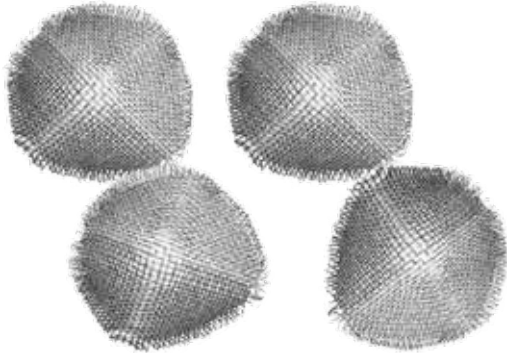

- Replacement screens for Xtreme Gladhands
- Prevents dirt from entering airline
- 20 each per bag

Part Number	Description	Replaces Phillips
GT-12-038	stainless steel dome style	12-038
GT-12-039	Stainless steel, flat style	12-039

In-Line Quick Release Valve



- Exhaust valves mount in-line between the gladhand and the tractor protection valve to speed up release of the trailer's service brakes
- Helps reduce wear on trailer brake components
- Helps improve brake timing

Part Number	Description	Ports	Replaces Tectran
GTA-80-1094	Mounts between tractor protection valve and trailer hose	1/2" NPTF	80-1094
GTA-80-1095	Mounts at gladhand end of trailer hose	1/2" NPTF	80-1095

GT-2610 Gladhand Pacifier

- Gladhand pacifiers are easily attached in any convenient location
- Simply plug into the gladhand when disconnected
- Prevents dirt and contaminants from entering the air system

Replaces Tectran 1011P





Rubber Grip GT-5343 Gladhand Grips

- Unique rubberized gladhand grips
- May be used on rubber hose assemblies or aircoils
- Protect hose/tubing during gladhand connection
- Allow gladhand bend restriction during tight turns

Part Number	Description	Replaces Tectran
GT-5343	Flexible grip gladhand grip 1 red and 1 blue	1011FG

GT-5341 - Anodized Gladhand Grips

- Helps prevent air line kinking at the fittings
- One piece design
- No screws or plastic parts
- Easy to install aluminum hex construction
- Class II anodized coating provides greater corrosion-resistance

The unique all hex design allows positive wrench leverage at both ends of handle.



PLASTIC GRIP GT-5340 Gladhandles

Standard
1 each red & blue in clamshell package

Part Number	Description	Replaces Tectran#
GT-5340	Gladhand set, standard	1011G



Brake Shoe Hardware Kits



Part Number	Replaces BWP	Replaces Euclid#	Contains	Use With
GTA-MK79	BWP MK79	E3869	2M-2724 Roller, 2 M-3355 Anchor Pin 1 M-3356 Return Spring 1 M-3357 Spring, 1 M-3358 Plate 2 M-3359 Washer, 2 M-2459 Lock Nut	Meritor (Rockwell) 15" Front Brake Shoes
GTA-MK39	BWP MK39	E2769S	2 M-1422 Anchor Pin, 2 M-596 Roller Pin 1M-2732 H.D. Spring, 2 M-747 Bushing	16 1/2" Shoes
GTA-MK72	BWP MK72	E2769HD	2 M-1422 Anchor Pin, 2 M-2204 Roller Pin 1 M-2732 H.D. Spring, 2 M-747 Bushing 2 M-1433 Retainer, 2 M-1500 Spring Pin	16 1/2" Shoes
GTA-MK7	BWP MK7	E1816HD	2 M-771 Anchor Pin, 2 M-596 Roller Pin 1 M-792 H.D. Spring, 1 M-747 Bushing 2 M-644 Retainer, 4 M-748 Washer 2 M-1500 Spring Pin, 4 M-1523 Lock Pin	Meritor/Dana 16 1/2" Universal Kit
GTA-MK10	BWP MK10		2 M-592 Roller, 2 M-612 Roller Pin 1 M-1014 H.D. Spring, 2 M-844 Spring	Eaton 4311 Shoes
GTA-MK42	BWP MK42	E3710S	2 M-2748 Anchor Pin, 2 M-596 Roller Pin 2 M-747 Bushing, 1 M-2732 H.D. Spring 2 M-1423 Spring, 2 M-1428 Retainer 1 M-1430 Cotter Pin, 2 M-1500 Spring Pin	Fruehauf/Propar XEM3 Shoes

BETTER PARTS BETTER PRICES!



Suspension

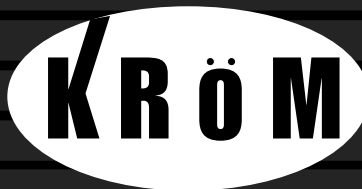

INTERNATIONAL

WORLD CLASS AIR SPRINGS

For OEM and Aftermarket

**CALL OR
EMAIL
TODAY FOR
CURRENT
LIST OF
PART #s
IN STOCK!**

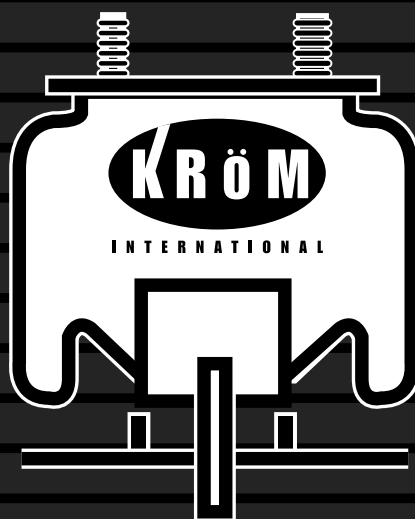

- 2.5 Million Cycles
- 144/Hrs. Salt Spray
- 100% Pressure Tested
- Standard 4mm Thick Plates
- Dupont Nylon Made in USA
- ISO Certified
- All Components Made IN HOUSE
- Level III PPAP Available

KRÖM Branded Air Springs are the highest Quality Springs on the Market. Other manufacturers are for reference only in this catalog. **KRÖM** International warranties all products to be manufactured of the highest quality standards and free of any defects.



King Pin Locks



Part Number	Description
GT-7201	Standard king pin lock, yellow
GT-611K	Keys only 2 each

- Steel fabricated body
- Yellow powder coated



Part Number	Description
GT-7201-E100	E-100 King pin lock orange
GT-E100K	Keys only 2 each
GT-7201-E101	E-101 King pin lock, orange
GT-E101K	Keys only 2 each

- Steel fabricated body
- Orange powder coated

Heavy Duty King Pin Locks



Part Number	Description
GT-7202-01	Heavy duty king pin lock (key#01)
GT-7202-01K	Key #01 only - for king pin lock
GT-7202-02	Heavy duty king pin lock (key#02)
GT-7202-02K	Key #02 only - for king pin lock
GT-7202-05	Heavy duty king pin lock (key #05)
GT-7202-05K	Key #05 only - for king pin lock
GT-7202-611K	Keys only for GT-7200 glandhand lock & GT-7201 king pin lock



GT-7208-Flag for king pin lock can be ordered separate or by adding "F" at end of part #
EXAMPLE: GT-7201F standard king-pin with flag

Glandhand Locks



Part Number	Description
GT-7200	Glandhand lock 611K-Key
GT-7200-E100	Glandhand lock E100K-Key
GT-7200-E101	Glandhand lock and E101K-Key

- Indestructible plastic bod
- Stainless steel & zinc plated hardware
- Multiple key patterns available



Part Number	Description
GT-E100K	Keys only for GT-7200
GT-E101K	Keys only for GT-7200-E100
GT-611K	Keys only for GT-72000-E101

**ONE KEY FITS YOUR KING PIN LOCK AND GLANDHAND LOCK!
SECURE YOUR TRAILER WITH TWO LOCKS ONE KEY!**



GT-7001- Coil Rack

- Heavy duty coil rack
- Powder coated

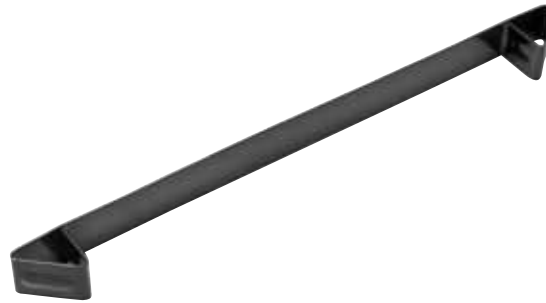

GT-1330 - Fifth Wheel Puller

- Fifth wheel hook
- Powder coated

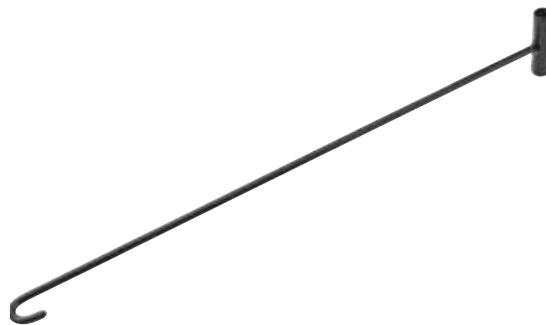

Slick Discs

- Polyethylene with plated snap ring
- Easy installation



GT-7100

Part Number	Description
GT-7100	32" fifth wheel slick disc
GT-7100R	Snap ring for slick disc
GT-7100WR	32" slick disc w/snap ring
GT-7101	36" fifth wheel
GT-7101WR	36" with snap ring

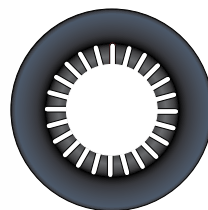

GT-7100R
Spring Steel Retaining Ring
Heat Tested

Note: Silver rings are low quality copies of Globetech rings



Emergency Triangle Kits



Part Number	Description
GT-8500	Triangle warning kit, 3 triangles per kit with plastic container

Emergency Triangle Kit

- Each kit contains three HD triangles packaged in a red storage box
- Durable fluorescent orange plastic with red reflectors are visible day or night.
- Snaps together for fast and easy set up
- Heavy weighted sand filled base provides stability even in windy conditions
- Friction pads on base keeps triangle in place on highway
- Meets all applicable FMVS 12 and SAE/DOT specifications
- Instructions for proper use molded in the cover and on all triangles

Make sure your vehicle meets FMVSS 125

- FMVSS 125 establishes shape, size and performance requirements for non-powered day and night warning devices that can be erected on or near the roadway to warn approaching traffic of the presence of a stopped vehicle. The purpose of this Standard is to reduce deaths and injuries due to rear-end collisions between moving traffic and disabled vehicles
- Required Application: buses and trucks with GVWR greater than 4,536 kg (10,000 lbs.)



GTK-20015 - Universal Lock Rod Assembly

Replaces: Power Brace
P50015 DL-DL Kit 165408

Lockrod Assembly Kit

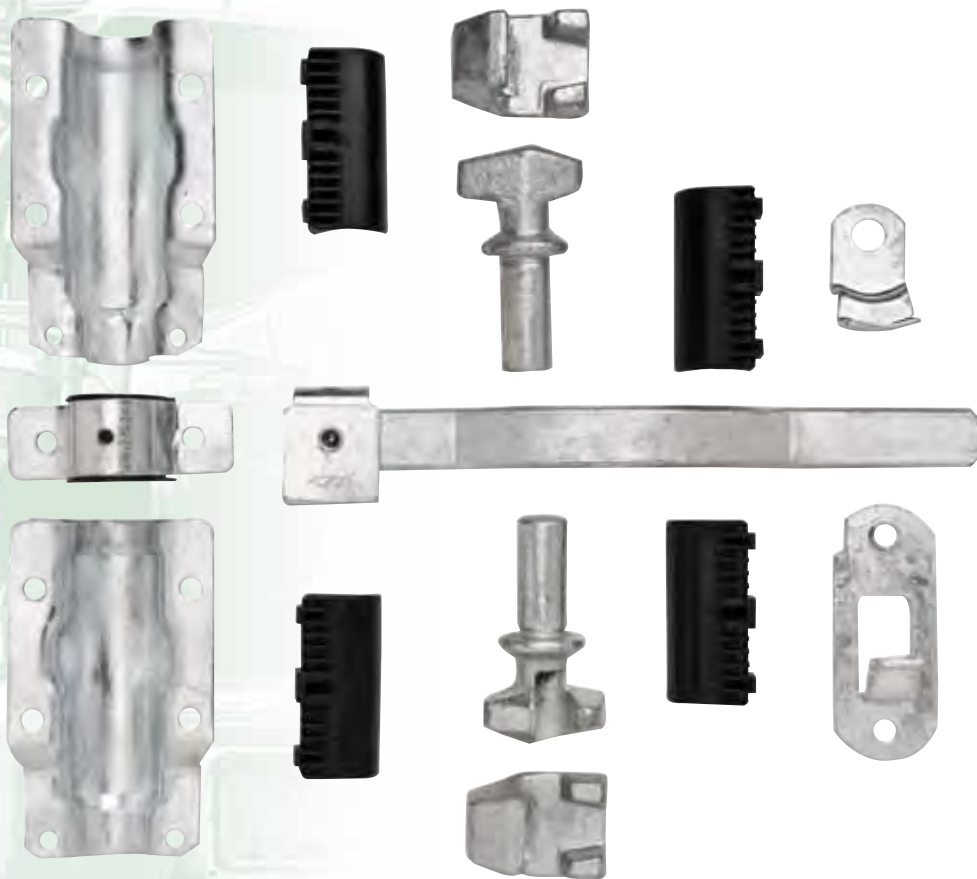

KIT - 50015

- Guide plates - 2
- Guide plate
- half bushings - 4
- Rod guide - 1
- Rod guide half bushings - 2
- Seal plate - 1
- Seal pin - 1

Cross Reference

Haldex-Midland

40010214
40010215
40010216
40010305
40010306
102434T
KN16743
KN20030
KN20031
KN20541
KN23000
KN26000
KN27000
KN28500
KN28510
KN28520
KN28600 (FF-2)
KN28601 (FF-2)
KN30300
KN30400
KN3546
KN44041
KN44051
KN44061
KN44071
KN4688
KN47001
KN47011
KN47081
KN48031
KN51000
KN54101
KN55001
Haltec
382
6A135
A100-VC-1
A100-VC-1
A100-VC-3
A-100-VC-8
DS-1
TV-501
TV-509
TV-510
TV-544D
TV-545D
TV-572
TV-573
James King
350
500
550
Koneta
430030
430040
041220
0422440
042424
042430
042436
062424
062430
062436
082424
082430
082436
203000
302424

Globetech

GTA-40010214
GTA-40010215
GTA-40010216
GTA-40010305
GTA-40010306
GT-6202
GTA-16743
GTA-20030
GTA-20031
GTA-20541
GTA-23000
GTA-26000
GTA-27000
GTA-28500
GTA-28510
GTA-28520
GTA-28600
GTA-28601
GTA-30300
GTA-30400
GTA-3546
GTA-44041
GTA-44051
GTA-44061
GTA-44071
GTA-4688
GTA-47001
GTA-47011
GTA-47081
GTA-48031
GTA-51000
GTA-54101
GTA-55001
Globetech
GT-TE-382
GT-45135
GT-VC1
GT-TL610
GT-VC-3
GT-VC-8
GT-DS-1
GT-TR501
GT-TR-509
GT-TR-510
GT-TR-544D
GT-TR-545D
GT-TR572
GT-573
Globetech
GT-1035
GT-1050
GT-1055
Globetech
GT-2047D
GT-2049
GT-1220RSM
GT-2440X
GT-2424RM
GT-2430RM
GT-2436RM
GT-2424C
GT-2430C
GT-2436C
GT-2424HDD
GT-2430HDD
GT-2436HDD
GT-3900
2424PSB

302430
302436
312424
312430
312436
372424
372430
372436
430030
523000
55000
Labelmaster
4-TPH
80SM-4CC
80SM-P
81-10FO
81-8FO
Meritor
31363-00
31373-00
31426-00
31427-00
R801073
R801074
R955205
R955329
R955335
R955336
R955337
R955341
R955342
R955349
R955365
Neway
90054007
90054074
90054075
90054076
90054079
90054088
90054107
90554241
90554243
K910058
PDC
51817
52407
53607
54807
56007
G53601
Phillips
4-45124
5-45044
5-45064
5-45084
5-45104
5-45164
5-46044
5-46064
5-46084
5-46104
5-46124
5-46164
5-46241
5-46271
5-46281
5-46291
5-46301

2430PSB
2436PSB
2424PSW
2430PSW
2436PSW
2424PPSW
2430PPSW
2436PPSW
GT-2047
GT-39585B
GT-395000
Globetech
GT-1103
GT-1100
GT-1100A
GT-1150
GT1151
Globetech
GT-4121
GT-4120
GT-4370
GT-4370S
GTA-R801073
GTA-R801074
GTA-065225
GTA-R955329
GTA-R955335
GTA-R955336
GTA-R955337
GTA-R955341
GTA-R955342
GTA-R955349
GTA-R955365
Globetech
GTA-90054007
GTA-90054074
GTA-90054075
GTA-90054076
GTA-90054079
GTA-90054088
GTA-90054107
GTA-90554241
GTA-90554243
GTA-910058
Globetech
GTK-15018
GTK-15024
GTK-15036
GTK-15048
GTK-15060
GTK-16036
Globetech
GT-35124
GT-35044
GT-35064
GT-35084
GT-35104
GT-35154
GT-36044
GT-36064
GT-36084
GT-3604
GT-36124
GT-3664
GT-36241
GT-36271
GT-36281
GT-36291
GT-36301

8-2101
8-2102
8-2111
8-2112
8-2121
8-2122
8-2123
8-2131
8-2132
8-2133
8-2135
8-2141
8-2142
8-2143
8-2145
8-2152
8-2153
8-2155
8-2163
8-2165
8-2172
8-2173
8-2175
8-2183
8-2185
11-312
11-315
11-320
11-340
11-5120
11-5150
11-5200
11-5400
12-038
12-039
12-206
12-236
12-306
12-310
12-820
12-8304
12-8305
12-8306
12-8307
12-8308
12-8309
12-8310
12-8311
12-8312
12-8404
12-8405
12-8406
12-8407
12-8408
12-8409
12-8410
12-8411
12-8504
12-8506
12-8508
12-8510
12-8604
12-8606
12-8608
12-8704
12-8706
12-8708
12-8710
12-8804

GT-3500
GT-3501
GT-3502
GT-3503
GT-3504
GT-3505
GT-3506
GT-3507
GT-3508
GT-3509
GT-3510
GT-3511
GT-3512
GT-3513
GT-3514
GT-3522
GT-3523
GT-3524
GT-3520
GT-3521
GT-3517
GT-3518
GT-3519
GT-3515
GT-3516
GTA-120606
GTA-151212
GTA-201212
GTA-151213
GTA-120606X
GTA-151212X
GTA-201212X
GTA-151213X
GTA-12-038
GTA-12-039
GT-5380
GT-5383
GT-5339
GT-5338
GT-5300
GTA-12-8304
GTA-12-8305
GTA-12-8306
GTA-12-8307
GTA-12-8308
GTA-12-8309
GTA-12-8310
GTA-12-8311
GTA-12-8312
GTA-12-8404
GTA-12-8405
GTA-12-8406
GTA-12-8407
GTA-12-8408
GTA-12-8409
GTA-12-8410
GTA-12-8411
GTA-12-8504
GTA-12-8506
GTA-12-8508
GTA-12-8510
GTA-12-8604
GTA-12-8606
GTA-12-8608
GTA-12-8704
GTA-12-8706
GTA-12-8708
GTA-12-8710
GTA-12-8804

12-8806
12-8808
12-8810
12-8904
12-8906
Phillips
12-8908
12-8910
12-9304
12-9305
12-9306
12-9307
12-9308
12-9308
12-9309
12-9310
12-9311
12-9312
12-9313
12-9404
12-9405
12-9406
12-9407
12-9408
12-9409
12-9410
12-9504
12-9506
12-9508
12-9604
12-9606
12-9608
15-320
15-320
15-326
15-335
15-335
15-336
15-400
15-430
15-600
15-610
15-630
15-710
15-720
15-720
15-721
15-730
15-730
15-740
15-765
15-766
15-767
15-769
15-775
15-788
15-788
16-713
16-713
16-714
16-714
17-103
17-106
17-111
17-116
17-120
17-125
17-148
17-150

GTA-12-8806
GTA-12-8808
GTA-12-8810
GTA-12-8904
GTA-12-8906
Globetech
GTA-12-8908
GTA-12-8910
GTA-12-9304
GTA-12-9305
GTA-12-9306
GTA-12-9307
GTA-12-9308
GTA-12-9308
GTA-12-9309
GTA-12-9310
GTA-12-9311
GTA-12-9312
GTA-12-9313
GTA-12-9404
GTA-12-9405
GTA-12-9406
GTA-12-9407
GTA-12-9408
GTA-12-9409
GTA-12-9410
GTA-12-9504
GTA-12-9506
GTA-12-9508
GTA-12-9604
GTA-12-9606
GTA-12-9608
GT-3010
GT-3010G
GT-3012
GT-3001
GT-3001G
GT-3002
GT-3014
GT-3004
GT-3016
GT-3006A
GT-3006B
GT-3007A
GT-3227
GT-3227E
GT-3227SP
GT-3007B
GT-3007E
GT-3200
GT-3203-D
GT-3017-G
GT-3203-G
GT-3203
GT-3204
GT-3227MB
GT-3227MZ
GT-3007D
GT-3227YD
GT-3007YD
GT-3227D
GT-5007
GT-5008
GT-5003
GT-5004
GT-5005
GT-5006
GT-5375
GT-5500-38

Cross Reference

Phillips 17-151 17-156 17-157 17-158 17-249 17-420 Ranger BTS-2024 BTS-2424 BTS-2424LS BTS-2430 BTS-2430LS BTS-3030 BTS-3030LS BTS-3036 BTS-3636 BTS-3030-4.5 BC 3030-WCR 3030LS-WCR BPS-3030 BPS-3030K BPS-3030KLS BPS-2024 BPS-3036 BSC-36 BSC-30LS 30SC-WCR BSC-30 BSC-24 BSC-20 BSC-16 BSC-12 BSC-09 RB-30DB RB006 RB30PS RB009 RB010 RB-30DC RB008 RB-9PR RB-12PR RB-16PR RB-20PR RB033 RB034 RB-36PR RB-9NPH RB-12NPH RB-16NPH RB-20NPH RB-24NPH RB020 RB-36NPH RB-D-9 RB-D-16 RB-D-24 RB-D-30 RB-D-303 RB-D-12 RB-D-20 RB-D-243 RB-D-36 RB053 RB9CK RB12CK RB16CK RB20CK	Globetech GT-5501-38 GT-5001-2 GT-5001-3 GT-5001-4 GT-5426 GT-5427 Globetech GTA-BC2024 GTA-BC2424 GTA-BC2424LS GTA-BC2430 GTA-BC2430LS GTA-BC3030 GTA-BC3030LS GTA-BC3036 GTA-BC3636 GTA-BC3030-4.5DB GTA-3030-WCR GTA-3030LS-WCR GTA-BC3030P GTA-BC3030PK GTA-BC3030PLS GTA-BC2024P GTA-BC3036P GTA-BC36 GTA-BC30LS GTA-BC30SC-WCR GTA-BC30 GTA-BC24 GTA-BC20 GTA-BC16 GTA-BC12 GTA-BC09 GTA-30DB GTA-006 GTA-30PS GTA-009 GTA-010 GTA-30DC GTA-008 GTA-9PR GTA-12PR GTA-16PR GTA-20PR GTA-24PR GTA-30PR GTA-36PR GTA-9NPH GTA-12NPH GTA-16NPH GTA-20NPH GTA-24NPH GTA-30NPH GTA-36NPH GT-5205 GT-5206 GT-5208 GT-5209 GT-5210 GT-5211 GT-5212 GT-5213 GT-5214 GTA-5280 GTA-5281 GTA-5282 GTA-5283 GTA-5284	RB016 RB36CK Reflexite V92 V92 V92-5649 Sealco 616 2550 21600 110139 110170 110171 110191 110197 110205 110376 110380 110410 110415 110500 110515 110700 110800 140270 140280 996555 17600B 17600B-1 Sloan 42113 44731 421010 421145 421146 421164 421165 421166 421167 421172 421173 421180 421247 590080 590081 590160 590161 590163 7R6122M S600 S607 S608 S609 S620 S629 S661 Stemco 330-3009 330-3024 330-3067 330-3077 330-3118 340-4009 340-4013 340-4024 340-4075 340-4095 340-4195 340-4370	GT-5285 GTA-5286 Globetech GT-27006 GT-27007 GT-27000 Globetech GTA-616 GTA-2550 GTA-21600 GTA-110139 GTA-110170 GTA-110171 GTA-110191 GTA-110197 GTA-110205 GTA-110376 GTA-110380 GTA-110410 GTA-110415 X-5 GTA-110515 GTA-110700 GTA-110800 GTA-140270 GTA-140280 GTA-996555 GTA-17600 GTA-17600B-1 Globetech GT-3310 GT-5347 GT-3309 GT-3324 GT-3325 GT-3315 GT-3316 GT-3306 GT-3307 GT-3326 GT-3327 GT-3311 GT-3308 GT-3303 GT-3304 GT-3300 GT-3301 GT-3302 GT-3317 GT-5251 GT-5254 GT-5256 GT-5257 GT-5253 GT-5252 GT-5255 Globetech GT-4006 GT-4025 GT-4004 GT-4021 GT-4008 GT-4009 GT-4013 GT-4024 GT-4075 GT-4095 GT-4195 GT-4370	340-4372 340-4975 340-5096 340-5097 342-4009 342-4013 342-4024 342-4195 343-4009 343-4024 343-4095 343-4195 343-4249 343-4370 343-4372 347-4009 347-4195 610-0065 610-0084 640-0001 640-0003 Sirco 9013 9015 9018 9020 333B B-9015 B-9015V Sirco 9013 9015 9018 9020 333B B-9015 B-9015V Tectran 102 103 104 105 106 Tectran 107 1021 1022 1023 1024 1025 1031 1041 1105 1106 1107 5031 9411 9412 10111 10234 17212 17215 17220 101112 101113 101114 101118 105501 107701	GT-4372 GT-4020 GT-4007F GT-4007 GT-4009G GT-4013G GT-4024G GT-4195G GT-4009S GT-4024S GT-4095S GT-4195S GT-4249S GT-4370S GT-4372S GT-4009H GT-4195H GT-4065 GT-4084 GT-4640H GT-4020H Globetech GT-4020 GT-4020H GT-4640 GT-4640H GT-46000A GT-4014 GT-4014B Globetech GT-4020 GT-4020H GT-4640 GT-4640H GT-46000A GT-4014 GT-4014B Globetech GTA-102 GTA-103 GTA-104 GTA-105 GTA-106 Globetech GTA-107 GTA-1021 GTA-1022 GTA-1023 GTA-1024 GTA-1025 GTA-1031 GTA-1041 GTA-1105 GTA-1106 GTA-1107 GT-3201 GT-5346NV GT-5346V GT-2600 GTA-10234 GTA-120606 GTA-151212 GTA-201212 GT-2599 GT-2604 GT-2603 GT-2608 GTA-105501 GTA-107701	161201 441004 441014 1055011 1077011 101115B 101115R 101119B 101119R 1011FG 1011G 1011P 1022-8 1022-8 10234-8 1023-8 1024-8 1025-8 1031-8 103-8 1041-8 104-8 106-8 107-8 1106-8 1107-8 113-6AB 113-8AB 114-66 114B-44 115-86 115-88 161201-6 161201-8 17215-040 17A15-40H 17B12H 17B15H 17B20H 181201-6 181201-8 660-15 660-20 660-25 660-30 661-15 661-20 661-25 661-30 667-7040 667-7050 670-11SG 670-12 670-21SG 670-22 70-31402 70-31403 791-67 7AAB122MG 7AAB152MG 7AAB202MG 7ATG222MG 7ATG522MG 7ATG542MG 7ATG622MW 7ATG642MW 7BTG222MG 7BTG522MG 7DTB222MW	GTA-161201 GT-5339S GT-5338S GTA-1055011 GTA-1077011 GT-2602 GT-2601 GT-2607 GT-2606 GT-5343 GT-5340 GT-2610 GTA-12-027 GTA-1022-8 GTA-10234-8 GTA-1023-8 GTA-1024-8 GTA-1025-8 GTA-1031-8 GTA-103-8 GTA-1041-8 GTA-104-8 GTA-106-8 GTA-107-8 GTA-1106-8 GTA-1107-8 GT-5257 GT-5256 GT-5254 GT-5255 GT-5251 GTA-161201-6 GTA-161201-8 GTA-151214 GTA-151214X GTA-120606X GTA-151212X GTA-201212X GTA-181201-6 GTA-181201-8 GT-3550 GT-3551 GT-3552 GT-3553 GT-3550P GT-3551P GT-3552P GT-3553P GT-3100 GT-3101 GT-3001 GT-3010 GT-3002 GT-3012 GTA-5342 GTA-5343 GT-3706 GT-3306 GT-3307 GT-3308 GT-3300 GT-3301 GT-3302 GT-3303 GT-3304 GT-3324 GT-3325 GT-3326
---	---	--	---	---	---	---	---

Cross Reference

Tectran	Globetech	36301	GT-5330
7DTB522MW	GT-3327	36390	GT-5350-90
7ETB222MG	GT-3309	30004	GT-2312
7ETB522MG	GT-3310	36101P	GT-5334X
7ETB542MG	GT-3311	36201P	GT-5334X
7R6122M	GT-3317	36301P	GT-5333X
7SAB122MG	GT-3315	38502W	GT-3338
7SAB152MG	GT-3316	50001	GT-5253
80-1094	GTA-80-1094	50005	GT-5255
80-1095	GTA-80-1095	50006	GT-5254
832SPR	GT-3600	50008	GT-5256
900R-32	GT-36281	50009	GT-5257
9400D-2	GT-5380	50010	GT-5251
9400D-2	GT-5380	50012	GT-5252
9400E-2	GT-5370	56121	GT-5337
9400E-2	GT-5370	56221	GT-5336
9400F-2	GT-5382	56321	GT-5335
9400F-2	GT-5382	9202	GT-5339S
9400G-2	GT-5371	9203	GT-5338S
9400G-2	GT-5371	9211	GT-5339
9400H-2	GT-5385	9212	GT-5338
9400H-2	GT-5385	1010-F18	GT-5345
9400J-2	GT-5384	Trailmobile	Globetech
9400J-2	GT-5384	700-7-14	GT-41226
9400L-2	GT-5381	700-7-15	GT-43068
9400L-2	GT-5381	Trux	Globetech
9400M-2	GT-5383	LT77S	GT-27LT77S
9400M-2	GT-5383	Trucklite	Globetech
9420-1	GT-5379	26330	GT-7460
A148	GT-451065	80360	GT-7450
A824	GT-45130	97960	GT-1007
HTS225	GTK-225	97962	GT-1008
HTS225	GTA-225	Utility	Globetech
HTS275	GTK-275	03-1250-006	GT-UTM006
HTS275	GTA-275	03-1250-025	GT-025
HTS306	GTK-306	03-1250-053	GT-UTM053
HTS306	GTA-306	03-1250-172	GT-UTM172
HTS344	GTK-344	03-1250-214	GT-UTM214
HTS344	GTA-344	03-1250-259	GT-UTM259
HTS356	GTK-356	Wabash	Globetech
HTS356	GTA-356	004400035	GT-04400035
HTS388	GTK-388	06300015	GT-1301
HTS388	GTA-388	06300028	GT-1302
HTS406	GTK-406	06300058	GT-1314
HTS406	GTA-406	06300094	GT-1303
HTS419	GTK-419	06300117	GT-1304
HTS419	GTA-419	06300118	GT-1305
HTS456	GTK-456	06300119	GT-1306
HTS456	GTA-456	063002201	GT-1334
SC-1	GT-5256	06300250	GT-1329
Todco	Globetech	06300693	GT-1307
61196	GT-1401	06300805	GT-1308
69035	GT-1400	06300844	GT-1315
Tramec	Globetech	06300985	GT-1316
30026	GT-2006	06301166	GT-1309
30027	GT-2027	06301167	GT-1310
30037	GT-2044	06301217	GT-1318
30039	GT-2042	06301964	GT-1312
30045	GT-2345	06302523	GT-1313
36001	GT-2600	06302613	GT-1317
36003	GT-2599	10600526	GT-6200
36101	GT-5332	21300053	GT-2108
36133	GT-5354	21400170	GT-2100
36181	GT-5352-45	21400177	GT-2105
36191	GT-5352-90	525461	GT-1328
36201	GT-5331	61174	GT-1402
36201	GT-5351-90	70225	GT-1403
36233	GT-5353	A1300017	GT-1300
36281	GT-5351-45		

INDEX

Part No.	Page No.	Part No.	Page No.	Part No.	Page No.
2406PSB.....	53	2605PSB.....	53	GT-1003.....	2
2406PSW.....	53	2605PSW.....	53	GT-1004.....	2
2424PHDB.....	29	A5247538.....	40	GT-1005.....	4
2424PHDW.....	29	D-312.....	40	GT-1006.....	2
2424PPSB.....	29	D-324.....	40	GT-1006A.....	2
2424PPSW.....	29	D-324A.....	40	GT-1007.....	2
2424PPSY.....	27	D-412.....	40	GT-1008.....	2
2424PSB.....	29	D-412A.....	40	GT-1009.....	2
2424PSBL.....	27	D-424.....	40	GT-1011.....	2
2424PSW.....	29	D-424A.....	40	GT-1035.....	3
2424PSY.....	27	D-472.....	40	GT-1035B.....	3
2424TPHDB.....	28	D-612.....	40	GT-1035L.....	3
2424TPPSB.....	28	D-624.....	40	GT-1050.....	3
2424TPSHDB.....	28	D-672.....	40	GT-1050L.....	3
2426PPSB.....	29	GEN2-0100.....	85-90	GT-1055.....	3
2427PPSB.....	29	GEN2-0101.....	85-90	GT-1055L.....	3
2427PPSW.....	29	GEN2-0180.....	85-90	GT-1100.....	5
2427PSB.....	29	GEN2-0210.....	85-90	GT-1100A.....	5
2427PSW.....	29	GEN2-0233.....	85-90	GT-1101.....	5
2427TPHDB.....	28	GEN2-0300.....	85-90	GT-1101A.....	5
2428PPSB.....	29	GEN2-0330.....	85-90	GT-1102.....	5
2428PPSW.....	29	GEN2-0470.....	85-90	GT-1105.....	4
2428PSW.....	29	GEN2-0584.....	85-90	GT-1106.....	16
2430PHDB.....	29	GEN2-0585.....	85-90	GT-1107.....	16
2430PHDW.....	29	GEN2-1010.....	85-90	GT-1108.....	6
2430PHDY.....	27	GEN2-1030.....	85-90	GT-1111.....	16
2430PPSB.....	29	GEN2-1031.....	85-90	GT-1150.....	5
2430PPSW.....	29	GEN2-2010.....	85-90	GT-1150W.....	5
2430PPSY.....	27	GEN2-2752.....	85-90	GT-1151.....	5
2430PSB.....	29	GEN2-2753.....	85-90	GT-1151W.....	5
2430PSBL.....	27	GEN2-3120.....	85-90	GT-1201.....	14
2430PSG.....	27	GEN2-5329.....	85-90	GT-1202.....	14
2430PSO.....	27	GEN2-5335.....	85-90	GT-12-038.....	139
2430PSR.....	27	GEN2-5336.....	85-90	GT-1217S.....	23
2430PSS.....	27	GEN2-5337.....	85-90	GT-1218S.....	23
2430PST.....	27	GEN2-5341.....	85-90	GT-1300.....	9
2430PSW.....	29	GEN2-5342.....	85-90	GT-1334.....	13
2430PSY.....	27	GEN2-5349.....	85-90	GT-1336.....	13
2430TPHDB.....	28	GEN2-5365.....	85-90	GT-1924S.....	23
2430TPPSB.....	28	GEN2-5374.....	85-90	GT-2000.....	39
2430TPPSW.....	28	GEN2-6010.....	85-90	GT-2006.....	39
2430TPSHDB.....	28	GEN2-6011.....	85-90	GT-2015S.....	23
2436PHDB.....	29	GEN2-801544.....	85-90	GT-2027.....	39
2436PHDW.....	29	GEN2-801545.....	85-90	GT-2036.....	41
2436PPSB.....	29	GEN2-801546.....	85-90	GT-2041.....	41
2436PPSW.....	29	GEN2-8154.....	85-90	GT-2042.....	39
2436PPSY.....	27	GEN2-AL91980.....	85-90	GT-2043.....	41
2436PSB.....	29	GEN2-AL919803.....	85-90	GT-2044.....	39
2436PSBL.....	27	GEN2-AL919806.....	85-90	GT-2045.....	41
2436PSG.....	27	GT-025.....	42	GT-2046.....	41
2436PSO.....	27	GT-04400035.....	4	GT-2047D.....	38
2436PSR.....	27	GT-1002.....	4	GT-2047L.....	38
2436PSW.....	29	GT-1002A.....	4	GT-2048D.....	38
2436TPHDB.....	28	GT-1002F.....	4	GT-2049.....	38
2436TPSHDB.....	28	GT-1002L.....	4	GT-2050.....	38
2436TPPSB.....	28			GT-2052D.....	38

INDEX

Part No.	Page No.	Part No.	Page No.	Part No.	Page No.
GT-2057.....	38	GT-2604.....	137	GT-27B6728SS.....	49
GT-2099.....	40	GT-2605GLO.....	136	GT-27B67C.....	49
GT-2100.....	42	GT-2605WS.....	136	GT-27B67SS.....	49
GT-2101.....	42	GT-2606.....	137	GT-27B68.....	49
GT-2102.....	42	GT-2607.....	137	GT-27B68C.....	49
GT-2103.....	42	GT-2608.....	137	GT-27B68SS.....	49
GT-2104.....	42	GT-2609.....	136	GT-27B7.....	50
GT-2105.....	42	GT-2610.....	139	GT-27B700.....	45
GT-2106.....	42	GT-2613.....	42	GT-27B71.....	50
GT-2107.....	42	GT-27000.....	47	GT-27B711.....	45
GT-2108.....	42	GT-27003.....	7,47	GT-27B71C.....	50
GT-2109.....	42	GT-27004.....	7,47	GT-27B71SS.....	50
GT-2312.....	39	GT-27005.....	7,47	GT-27B7C.....	50
GT-2345.....	39	GT-27006.....	7,47	GT-27B7SS.....	50
GT-2406.....	53	GT-27007.....	7,47	GT-27K700.....	45
GT-2414S.....	23	GT-2701C.....	45	GT-27K711.....	45
GT-2418S.....	23	GT-2701SS.....	45	GT-27LT77S.....	50
GT-2424AS.....	25	GT-2702C.....	45	GT-27RT25.....	4
GT-2424C.....	22	GT-2702SS.....	45	GT-27RT35.....	4
GT-2424CD.....	21	GT-27051.....	46	GT-3001.....	60
GT-2424D.....	19	GT-27053.....	46	GT-3001A.....	60
GT-2424GFB.....	18	GT-27069.....	47	GT-3002.....	60
GT-2424HDD.....	25	GT-27150.....	48	GT-3004.....	60
GT-2424S.....	23	GT-2721B.....	44	GT-3005.....	60
GT-2424XD.....	24	GT-2723B.....	43	GT-3006A.....	60
GT-2430AS.....	25	GT-2725A.....	43	GT-3006B.....	60
GT-2430C.....	22	GT-2725B.....	43	GT-3007.....	99
GT-2430CD.....	21	GT-2725B70.....	43,46	GT-3007A.....	60
GT-2430D.....	19	GT-27270.....	48	GT-3007B.....	60
GT-2430GFB.....	18	GT-27277.....	48	GT-3007E.....	60
GT-2430HDD.....	25	GT-2729B.....	43	GT-3017.....	65
GT-2430M.....	26	GT-2733B.....	43	GT-3017-15.....	65
GT-2430RT.....	26	GT-2735A.....	43	GT-3017-15P.....	65
GT-2430S.....	23	GT-2735B.....	43	GT-3017-20.....	65
GT-2430XD.....	24	GT-2735B40.....	43	GT-3017-20P.....	65
GT-2436AS.....	25	GT-27404.....	48	GT-3017-30.....	65
GT-2436C.....	22	GT-27516.....	46	GT-3017-30P.....	65
GT-2436CD.....	21	GT-27517.....	46	GT-3017-G.....	65
GT-2436D.....	19	GT-2781A.....	44	GT-3100.....	62
GT-2436HDD.....	25	GT-2781B.....	44	GT-3101.....	62
GT-2436M.....	26	GT-2782A.....	44	GT-3200.....	63
GT-2436S.....	23	GT-2782B.....	44	GT-3201.....	66
GT-2436XD.....	24	GT-2783B.....	44	GT-3203.....	65
GT-2440HDD.....	25	GT-2784B.....	44	GT-3203C.....	65
GT-2440XD.....	24	GT-27864.....	48	GT-3203-D.....	65
GT-2442HDD.....	25	GT-27865.....	48	GT-3203-G.....	65
GT-2442XD.....	24	GT-27868.....	48	GT-3204.....	65
GT-2599.....	137	GT-27870.....	48	GT-3204-C.....	65
GT-2600.....	137	GT-27B57.....	49	GT-3204-D.....	65
GT-2601.....	137	GT-27B5728.....	49	GT-3204-G.....	65
GT-2601WS.....	137	GT-27B5728SS.....	49	GT-3227.....	57
GT-2602.....	137	GT-27B57SS.....	49	GT-3227E.....	57
GT-2602WS.....	137	GT-27B67.....	49	GT-3300.....	57
GT-2603.....	137	GT-27B6728.....	49	GT-3301.....	57
GT-2603WS.....	137	GT-27B6728C.....	49	GT-3302.....	57

INDEX

Part No.	Page No.	Part No.	Page No.	Part No.	Page No.
GT-3303.....	57	GT-3714.....	63	GT-4020H.....	72
GT-3304.....	57	GT-3715.....	63	GT-4021.....	73
GT-3306.....	57	GT-3715W.....	63	GT-4024.....	70
GT-3307.....	57	GT-3801.....	67	GT-4024S.....	70
GT-3308.....	57	GT-3802.....	67	GT-4025.....	70,74
GT-3309.....	58	GT-3802-R.....	67	GT-4040.....	80
GT-3310.....	58	GT-3802-G.....	67	GT-4065.....	71
GT-3311.....	58	GT-3804.....	67	GT-4075.....	71
GT-3315.....	58	GT-3805.....	67	GT-4084.....	71
GT-3316.....	58	GT-3806.....	67	GT-4095.....	71
GT-3317.....	58	GT-3807.....	67	GT-4095S.....	71
GT-3320.....	99	GT-3808.....	67	GT-4101.....	80
GT-3321.....	99	GT-3809.....	67	GT-4120.....	79
GT-3322.....	99	GT-3810.....	67	GT-4121.....	79
GT-3324.....	59	GT-3900.....	52	GT-4122.....	79
GT-3325.....	59	GT-391300.....	54	GT-41226.....	77
GT-3326.....	59	GT-391301.....	54	GT-4123.....	79
GT-3327.....	59	GT-391585.....	54	GT-4195.....	70
GT-33333.....	N/A	GT-391590.....	54	GT-4195G.....	70
GT-3337.....	61	GT-391600.....	55	GT-4195N.....	70
GT-3338.....	61	GT-391601.....	55	GT-4195S.....	70
GT-3338G.....	61	GT-391625.....	54	GT-4224XD.....	27
GT-3400.....	66	GT-391626.....	54	GT-4249S.....	71
GT-3401.....	66	GT-39414.....	53	GT-4300.....	80
GT-3402.....	64	GT-39415.....	53	GT-43068.....	77
GT-3403.....	64	GT-39416.....	53	GT-4370.....	78
GT-3550.....	66	GT-395000.....	55	GT-4370S.....	78
GT-3551.....	66	GT-395001.....	55	GT-4372.....	78
GT-3552.....	66	GT-39585B.....	51	GT-4372S.....	78
GT-3553.....	66	GT-39585FB.....	51	GT-443638.....	27
GT-3600.....	99	GT-39585HB.....	52	GT-45130.....	81
GT-3604YD.....	66	GT-39585LM.....	52	GT-45135.....	81
GT-3607.....	66	GT-4000.....	69,73	GT-451065.....	81
GT-3612.....	62	GT-4001.....	73	GT-46000A.....	77
GT-3613.....	62	GT-4001BLK.....	73	GT-4640.....	71
GT-3614.....	62	GT-4001RED.....	73	GT-4912.....	71,73
GT-3614-2.....	62	GT-4002.....	69,73	GT-4AG2106.....	77
GT-3615.....	62	GT-4003.....	69	GT-4AG2107.....	77
GT-3616.....	62	GT-4004.....	74	GT-4AG2111.....	77
GT-3624.....	62	GT-4005.....	73	GT-4E5568L.....	76
GT-36044.....	64	GT-4006.....	69,74	GT-4E5568R.....	77
GT-36064.....	64	GT-4007.....	70	GT-4E5977L.....	78
GT-36084.....	64	GT-4007F.....	70,74	GT-4E5977R.....	79
GT-36104.....	64	GT-4008.....	69	GT-4E5988L.....	80
GT-36124.....	64	GT-4009.....	69	GT-4E5988R.....	81
GT-36164.....	64	GT-4009G.....	69	GT-4E7895L.....	82
GT-36241.....	64	GT-4009H.....	69	GT-4E7895R.....	83
GT-36271.....	64	GT-4009K.....	69	GT-4E7896L.....	84
GT-36281.....	64	GT-4009P.....	69	GT-4E7896R.....	85
GT-36291.....	64	GT-4009S.....	69	GT-5001.....	107
GT-36301.....	64	GT-4009SK.....	69	GT-5001-2.....	108
GT-36302.....	64	GT-4013.....	70	GT-5001-3.....	108
GT-36304.....	64	GT-4014.....	73	GT-5001-4.....	108
GT-3704YD.....	63	GT-4014B.....	73	GT-5002.....	107
GT-3706.....	63	GT-4020.....	72	GT-5003.....	107
GT-3707YD.....	63	GT-4020B.....	72	GT-5004.....	107

INDEX

Part No.	Page No.	Part No.	Page No.	Part No.	Page No.
GT-5006.....	107	GT-5345FX.....	138	GT-7100.....	144
GT-5007.....	107	GT-5346NV.....	138	GT-7100R.....	144
GT-5008.....	107	GT-5346V.....	138	GT-7100WR.....	144
GT-5010.....	108	GT-5347.....	138	GT-7101.....	144
GT-5011.....	108	GT-5350.....	134	GT-7101WR.....	144
GT-5012.....	108	GT-5351-45.....	134	GT-7200.....	138
GT-5014.....	107	GT-5351-90.....	134	GT-7200-E100.....	138
GT-5014A.....	107	GT-5351P-45.....	134	GT-7200-E101.....	138
GT-5015.....	107	GT-5351P-90.....	134	GT-7201.....	143
GT-5016A.....	107	GT-5352-45.....	134	GT-7201-E100.....	143
GT-5031.....	107	GT-5352-90.....	134	GT-7202-01.....	143
GT-5205.....	95	GT-5352P-45.....	134	GT-7202-01K.....	143
GT-5206.....	95	GT-5352P-90.....	134	GT-7202-02.....	143
GT-5208.....	95	GT-5370.....	109	GT-7202-02K.....	143
GT-5209.....	95	GT-5371.....	109	GT-7202-05.....	143
GT-5210.....	95	GT-5372.....	109	GT-7202-05K.....	143
GT-5211.....	95	GT-5373.....	136	GT-7202-0611K.....	107
GT-5212.....	95	GT-5374.....	136	GT-7208.....	107
GT-5213.....	95	GT-5375.....	107	GT-7460.....	68
GT-5214.....	95	GT-5375A.....	107	GT-7461.....	68
GT-5251.....	106	GT-5376.....	99	GT-7600B.....	68
GT-5252.....	106	GT-5379.....	99	GT-7600BLK.....	75
GT-5253.....	106	GT-5380.....	109	GT-7600GLOBETECH.....	75
GT-5254.....	106	GT-5381.....	109	GT-7710.....	75
GT-5255.....	106	GT-5382.....	109	GT-7711.....	64
GT-5256.....	106	GT-5383.....	109	GT-7712.....	64
GT-5257.....	106	GT-5384.....	109	GT-7713.....	64
GT-5280.....	95	GT-5385.....	109	GT-848S.....	64
GT-5281.....	95	GT-5391.....	99,108	GT-8500.....	27
GT-5282.....	95	GT-5392.....	99,108	GT-9014.....	144
GT-5283.....	95	GT-5400.....	110	GT-9015.....	37
GT-5284.....	95	GT-5400A.....	110	GT-9016.....	37
GT-5285.....	95	GT-5400B.....	110	GT-9017.....	37
GT-5286.....	95	GT-5400C.....	110	GT-9017B.....	37
GT-5300.....	105	GT-5401.....	110	GT-9017PPB.....	37
GT-5317.....	135	GT-5402.....	110	GT-9017PPY.....	37
GT-5327.....	135	GT-5402A.....	110	GT-9019.....	37
GT-5330.....	134	GT-5402B.....	110	GT-9020L.....	37
GT-5330A.....	134	GT-5403.....	110	GT-9020R.....	37
GT-5331.....	134	GT-5404.....	110	GT-9021L.....	37
GT-5331A.....	134	GT-5405.....	110	GT-9021R.....	37
GT-5332.....	134	GT-5406.....	110	GT-9023.....	37
GT-5332A.....	134	GT-5421.....	106	GT-9024.....	37
GT-5335.....	136	GT-5422.....	106	GT-9025.....	37
GT-5336.....	136	GT-5423.....	106	GT-9026.....	37
GT-5337.....	137	GT-5424.....	106	GT-9032B.....	37
GT-5338.....	135	GT-5425.....	106	GT-9032W.....	37
GT-5338S.....	135	GT-5426.....	106	GT-9034.....	37
GT-5339.....	135	GT-5427.....	107	GT-9035.....	37
GT-5339S.....	135	GT-5500-12.....	108	GT-9036.....	37
GT-5340.....	140	GT-5500-38.....	108	GT-TE382.....	37
GT-5341.....	140	GT-5501-12.....	108	GT-TL610.....	82
GT-5342TB.....	140	GT-5501-38.....	108	GT-TR501.....	83
GT-5343.....	140	GT-611K.....	138	GT-TR509.....	82
GT-5345.....	138	GT-7001.....	144	GT-TR510.....	82

INDEX

Part No.	Page No.	Part No.	Page No.	Part No.	Page No.
GT-TR544D.....	82	GTA-1031-8.....	102	GTA-1238F45.....	101
GT-TR545D.....	82	GTA-104.....	102	GTA-1238F46.....	101
GT-TR572.....	82	GTA-104-8.....	102	GTA-1238F48.....	101
GT-TR573.....	82	GTA-1041.....	102	GTA-1238F50.....	101
GT-UTM006.....	39	GTA-1041-8.....	102	GTA-1238F52.....	101
GT-UTM053.....	39	GTA-105.....	102	GTA-1238F54.....	101
GT-UTM172.....	39	GTA-105501.....	103	GTA-1238F56.....	101
GT-UTM214.....	39	GTA-106.....	102	GTA-1238F60.....	101
GT-UTM259.....	39	GTA-106-8.....	102	GTA-1238F66.....	101
GT-VC-1.....	83	GTA-107.....	102	GTA-1238F72.....	101
GT-VC-3.....	83	GTA-107-8.....	102	GTA-1238F84.....	101
GT-VC-8.....	83	GTA-107695.....	131	GTA-1238S08.....	101
GTA-006.....	94	GTA-1077011.....	103	GTA-1238S11.....	101
GTA-010.....	94	GTA-107796.....	131	GTA-1238S12.....	101
	94	GTA-107799.....	131	GTA-1238S14.....	101
	94	GTA-107800.....	131	GTA-1238S16.....	101
GTA-065066.....	125	GTA-109493.....	131	GTA-1238S18.....	101
GTA-065067.....	125	GTA-109495.....	133	GTA-1238S20.....	101
GTA-065104.....	126	GTA-109578.....	131	GTA-1238S22.....	101
GTA-065145.....	127	GTA-109579.....	131	GTA-1238S24.....	101
GTA-065146.....	127	GTA-109869.....	131	GTA-1238S26.....	101
GTA-065164.....	114	GTA-109994.....	133	GTA-1238S28.....	101
GTA-065167.....	114	GTA-110170.....	129	GTA-1238S30.....	101
GTA-065170.....	114	GTA-110171.....	129	GTA-1238S32.....	101
GTA-065172.....	114	GTA-110197.....	128	GTA-1238S34.....	101
GTA-065174.....	114	GTA-110200.....	127	GTA-1238S36.....	101
GTA-065175.....	114	GTA-110205.....	127	GTA-1238S38.....	101
GTA-065178.....	114	GTA-110415.....	128	GTA-1238S40.....	101
GTA-065179.....	114	GTA-1105.....	102	GTA-1238S42.....	101
GTA-065225.....	131	GTA-110570.....	122	GTA-1238S44.....	101
GTA-065437.....	129	GTA-1106.....	102	GTA-1238S46.....	101
GTA-065439.....	129	GTA-1107-8.....	102	GTA-1238S48.....	101
GTA-065612.....	131	GTA-1107.....	102	GTA-1238S50.....	101
GTA-1003100.....	133	GTA-1108-8.....	102	GTA-1238S52.....	101
GTA-101112.....	130	GTA-12000.....	100	GTA-1238S54.....	101
GTA-101622.....	130	GTA-120606.....	97	GTA-1238S56.....	101
GTA-102.....	102	GTA-120606X.....	98	GTA-1238S60.....	101
GTA-1021.....	102	GTA-12352.....	127	GTA-1238S66.....	101
GTA-1022.....	103	GTA-1238F08.....	101	GTA-1238S72.....	101
GTA-1022-8.....	103	GTA-1238F12.....	101	GTA-1238S80.....	101
GTA-1023.....	103	GTA-1238F14.....	101	GTA-1238S84.....	101
GTA-1023-8.....	103	GTA-1238F16.....	101	GTA-12PR.....	94
GTA-10234.....	103	GTA-1238F18.....	101	GTA-131081.....	128
GTA-10234.....	103	GTA-1238F20.....	101	GTA-151212.....	97
GTA-1024.....	103	GTA-1238F22.....	101	GTA-151212X.....	98
GTA-1024-8.....	103	GTA-1238F24.....	101	GTA-151213.....	97
GTA-1025.....	103	GTA-1238F26.....	101	GTA-151213X.....	98
GTA-1025-8.....	103	GTA-1238F28.....	101	GTA-151214.....	97
GTA-102626.....	126	GTA-1238F30.....	101	GTA-16201.....	102
GTA-102761.....	130	GTA-1238F32.....	101	GTA-161201-6.....	102
GTA-103.....	102	GTA-1238F34.....	101	GTA-161201-8.....	102
GTA-103009.....	126	GTA-1238F36.....	101	GTA-16743.....	121
GTA-103010.....	126	GTA-1238F38.....	101	GTA-16NPH.....	94
GTA-103028.....	126	GTA-1238F40.....	101	GTA-16PR.....	94
GTA-103-8.....	102	GTA-1238F42.....	101	GTA-17600.....	121
GTA-1031.....	102	GTA-1238F44.....	101	GTA-181201.....	102

INDEX

Part No.	Page No.	Part No.	Page No.	Part No.	Page No.
GTA-181201-6.....	102	GTA-26000.....	125	GTA-3838F22.....	101
GTA-181201-8.....	102	GTA-27000.....	124	GTA-3838F24.....	101
GTA-1922-01-1.....	104	GTA-276566.....	122	GTA-3838F26.....	101
GTA-19225-01-1.....	104	GTA-276567.....	122	GTA-3838F28.....	101
GTA-1923-01-1.....	104	GTA-277863.....	121	GTA-3838F30.....	101
GTA-1924-01-1.....	104	GTA-278614.....	122	GTA-3838F32.....	101
GTA-1924-02-1.....	104	GTA-278615.....	122	GTA-3838F34.....	101
GTA-1924-04-1.....	104	GTA-279000.....	130	GTA-3838F36.....	101
GTA-1924-05-1.....	104	GTA-279472.....	124	GTA-3838F38.....	101
GTA-1924-07-1.....	104	GTA-280479.....	122	GTA-3838F40.....	101
GTA-1926-01-1.....	104	GTA-281865.....	127	GTA-3838F42.....	101
GTA-1926-02.....	104	GTA-284143.....	129	GTA-3838F44.....	101
GTA-1926-02-1.....	104	GTA-284412.....	121	GTA-3838F45.....	101
GTA-1926-04-1.....	104	GTA-28500.....	127	GTA-3838F46.....	101
GTA-1926-05.....	104	GTA-28510.....	127	GTA-3838F48.....	101
GTA-1926-05-1.....	104	GTA-28520.....	127	GTA-3838F50.....	101
GTA-1926-07-1.....	104	GTA-28600.....	123	GTA-3838F52.....	101
GTA-1928-01.....	104	GTA-28601.....	123	GTA-3838F54.....	101
GTA-1928-01-1.....	104	GTA-286171.....	121	GTA-3838F56.....	101
GTA-1928-02.....	104	GTA-286364.....	129	GTA-3838F60.....	101
GTA-1928-02-1.....	104	GTA-286370.....	128	GTA-3838F66.....	101
GTA-1928-05.....	104	GTA-286771.....	121	GTA-3838F72.....	101
GTA-1928-05-1.....	104	GTA-286773.....	121	GTA-3838F84.....	101
GTA-1928-07-1.....	104	GTA-288239.....	125	GTA-3838S08.....	101
GTA-1930-01-1.....	104	GTA-289182.....	126	GTA-3838S12.....	101
GTA-1932-01-1.....	104	GTA-289714.....	126	GTA-3838S14.....	101
GTA-20030.....	123	GTA-30300.....	128	GTA-3838S16.....	101
GTA-20031.....	123	GTA-30400.....	128	GTA-3838S18.....	101
GTA-201212.....	97	GTA-30DB.....	94	GTA-3838S20.....	101
GTA-201212X.....	98	GTA-30DC.....	94	GTA-3838S22.....	101
GTA-205105.....	129	GTA-30NPH.....	94	GTA-3838S24.....	101
GTA-20541.....	123	GTA-30PR.....	94	GTA-3838S26.....	101
GTA-20NPH.....	94	GTA-31527.....	133	GTA-3838S28.....	101
GTA-20PR.....	94	GTA-33100.....	132	GTA-3838S30.....	101
GTA-21102.....	118	GTA-34100.....	118	GTA-3838S32.....	101
GTA-21103.....	118	GTA-34200.....	118	GTA-3838S34.....	101
GTA-22102.....	118	GTA-35100.....	118	GTA-3838S36.....	101
GTA-22103.....	118	GTA-35200.....	118	GTA-3838S38.....	101
GTA-224.....	133	GTA-3546.....	125	GTA-3838S40.....	101
GTA-224-2.....	133	GTA-36NPF.....	94	GTA-3838S42.....	101
GTA-23102.....	118	GTA-36PR.....	94	GTA-3838S44.....	101
GTA-24100.....	118	GTA-38000.....	100	GTA-3838S46.....	101
GTA-24102.....	118	GTA-3812F144		GTA-3838S48.....	101
GTA-24103.....	118	GTA-3812F144B		GTA-3838S50.....	101
GTA-24NPH.....	94	GTA-3812F144R		GTA-3838S52.....	101
GTA-24PR.....	94	GTA-3812F180		GTA-3838S54.....	101
GTA-25100.....	118	GTA-3812F180B		GTA-3838S56.....	101
GTA-25102.....	118	GTA-3812F180R		GTA-3838S60.....	101
GTA-25103.....	118	GTA-3812F240		GTA-3838S66.....	101
GTA-228600.....	130	GTA-3838F08.....	101	GTA-3838S72.....	101
GTA-228750.....	124	GTA-3838F12.....	101	GTA-3838S84.....	101
GTA-229635.....	122	GTA-3838F120.....	101	GTA-40010140.....	115
GTA-229859.....	126	GTA-3838F14.....	101	GTA-40010141.....	115
GTA-229860.....	126	GTA-3838F16.....	101	GTA-40010142.....	115
GTA-23000.....	122	GTA-3838F18.....	101	GTA-40010143.....	115
GTA-23800.....	122	GTA-3838F20.....	101	GTA-40010144.....	115

Index

INDEX

Part No.	Page No.	Part No.	Page No.	Part No.	Page No.
GTA-40010211.....	117	GTA-R801074.....	114		
GTA-40010212.....	117	GTA-SC1.....	105		
GTA-40010214.....	117	GTK-20015.....	146		
GTA-40010215.....	116				
GTA-40010216.....	116				
GTA-40010305.....	116				
GTA-40010306.....	116				
GTA-41100.....	118				
GTA-41106.....	118				
GTA-42100.....	118				
GTA-42106.....	118				
GTA-43100.....	118				
GTA-43016.....	118				
GTA-5001247.....	131				
GTA-5342.....	105				
GTA-5343.....	105				
GTA-800404.....	131				
GTA-800405.....	131				
GTA-80-1094.....	139				
GTA-80-1095.....	139				
GTA-90054007.....	124				
GTA-90054074.....	129				
GTA-90054075.....	129				
GTA-90054076.....	129				
GTA-90054079.....	129				
GTA-90054088KIT.....	125				
GTA-90054107.....	125				
GTA-90554241.....	124				
GTA-90554243.....	124				
GTA-910058.....	124				
GTA-A10005.....	128				
GTA-A4688.....	130				
GTA-A4740.....	123				
GTA-A5000.....	130				
GTA-BC2024.....	93				
GTA-BC24.....	93				
GTA-BC2424.....	93				
GTA-BC2424LS.....	93				
GTA-BC2430.....	93				
GTA-BC2430LS.....	93				
GTA-BC30.....	93				
GTA-BC3030.....	93				
GTA-BC3030LS.....	93				
GTA-BC3030PK.....	93				
GTA-BC3030PLSK.....	93				
GTA-BC3030V.....	93				
GTA-BC3036.....	93				
GTA-BC30LS.....	93				
GTA-BC30N.....	93				
GTA-BC30SC-WCR.....	93				
GTA-BC3636.....	93				
GTA-G8602.....	123				
GTA-K022105.....	131				
GTA-M7102.....	123				
GTA-M7102-K.....	123				
GTA-R801073.....	114				

WARRANTY POLICY

GLOBETECH Manufacturing warrants its products to be free from manufacturing defects for a period of one year from date of shipment. Buyer's exclusive remedy and seller's sole liability hereunder shall be limited to refund of the purchase price or replacement of the product shown to be other than as warranted. Conditions resulting from misuse, negligence, alteration, accident, or improper installation, maintenance, or application shall absolve seller of all liability. The foregoing constitutes the sole warranty of GLOBETECH Manufacturing with respect to its products and in lieu of all other warranties, expressed or implied, including any implied warranties of merchantability or of the fitness for a particular purpose. In no event and under no circumstances, shall GLOBETECH Manufacturing be liable for consequential or special damages.

RETURN POLICY

GLOBETECH Manufacturing will only allow returns upon approval and each return is subject to 25% restocking fee. Custom-made products may not be returned. Each return requires an RGA number issued by GLOBETECH Manufacturing. Customers must pay freight on all returns, and package items in such a way that makes our RGA number clear and obvious. All products must be in excellent condition, suitable for resale. We reserve the right to refuse any and all requests for product returns, based on poor condition of product, or on obsolescence of a particular item or product line. Credit for returns shall be in the form of a credit to customers account for use against further purchase.



Phone: 937-274-5587
Fax: 937-274-6102

www.gtmanufacturing.com



72,000 SQ FT
Dedicated to Manufacturing and
Distribution. Dayton, Ohio

40,000 SQ FT
Packaging and Distribution

12,000 SQ FT
Mudflap Production

20,000 SQ FT
Brake Chamber Assembly
Brake Hose Assembly
Testing
Administrative

**Proudly manufacturing and distributing
Truck & Trailer parts since 1992.**

Thank You For Your Business

**President,
Tim Begley**



Corporate Office Dayton, Ohio

